

TP-47



REVISION OF THE USER GUIDE

Due to continuing improvements, the information contained in this user manual, the features and design of this device are subject to be changed without prior notice.

<u>Edition/ Revision</u>	<u>Reference</u>	<u>Date</u> (week/year)	<u>Chapters updated</u>

TABLE OF CONTENTS

User Guide**2**

TP-47	2
1. SPECIFICATIONS	3
2. IMPORTANT SAFETY INSTRUCTIONS	4
3. CAUTION	5
4. OVERVIEW	6
5. FUNCTION KEYS	7
6. POWER ON	8
7. OPERATING INSTRUCTIONS	9
8. TPMS TIRE PRESSURE MONITORING SYTEM	10
9. GLOSSARY	11
TOOL USAGE	13
1. CHECK SENSOR.....	13
2. SERVICE TPMS.....	16
3. PROGRAM SENSOR.....	21
4. KEYFOB TEST	21
SETTINGS	26
1. ENTER SETTINGS MENU.....	26
ABOUT	29
1. ENTER THE ABOUT MENU	26
MISCELLANEOUS	31
1. CHARGE	31
2. SAFETY BATTERY AND CHARGE INFORMATION.....	31
3. LIMITED HARDWARE WARRANTY	32

TP-47 TPMS TOOL

1. SPECIFICATIONS

Battery Type:	Rechargeable Lithium-Ion
Battery Life:	Approximately 300 activations per full charge.
Dimensions (Max. L,W,D):	7.9" x 4.7" x 1.6" (20.0 cm x 12.0 cm x 4.0 cm).
Case Material:	High Impact ABS.
Response Frequency:	Main frequencies: 315 MHz and 433.92 MHz (supporting most specific frequencies).
Low Battery Indication:	LCD bar graph display.
Weight :	1.37 lbs.
Temperature:	Operating: -4°F to 131°F (-20°C to +55°C). Storage: -40°F to 140°F (-40°C to +60°C).
Operating Altitude:	Up to 6560 ft (2000 m).



Product content:

- TPMS Instrument.
- USB cable.
- Charger with Universal Adapters.

2. IMPORTANT SAFETY INSTRUCTIONS

Do not discard. Retain for future reference.

This device complies with:

- Part 15 of the FCC Rules (FCC ID: 2ABSJ-VT46)
- CE / CEM standards
- ROHS standards

Operation is subject to the following two conditions:

- (1) This device will not cause harmful interference, and
- (2) This device will accept any interference received, including interference that may cause undesired or improper operation.

WARNING: This product emits electromagnetic and electronically generated waves that may interfere with the safe operation of **pacemakers**.

Individuals that have pacemakers should never use this product.



WARNING:



Do not use on live electrical circuits.

Please read instructions before use.

Wear safety goggles. (User and bystanders).

Risk of entanglement.

Read the Warranty, Safety and recycling information at the end of this user guide.

3. CAUTION

PLEASE READ THESE INSTRUCTIONS BEFORE USE

Your Tire Pressure Monitoring (TPM) tool has been designed to be durable, safe, and reliable when properly used.

All **TPMS TOOLS** are intended for use only by qualified and trained automotive technicians or in a light industrial repair shop environment. Please read all instructions below before use. Always follow these safety instructions. If you have any questions pertaining to the safe or reliable use of this tool, please call your local dealer.

1. Read All Instructions

All warnings on the tool and in this manual should be adhered to. All operating instructions should be followed.

2. Retain Instructions

The safety and operating instructions should be retained for future reference.

3. Heed Warnings

Users and bystanders must wear safety goggles and must read instructions before use. Do not use on live electrical circuits, risk of entanglement.

4. Cleaning

Clean with a soft dry cloth, or if necessary, a soft damp cloth. Do not use any harsh chemical solvents such as acetone, thinner, brake cleaner, alcohol, etc as this may damage the plastic surface.

5. Water & Moisture

Do not use this tool where contact or immersion in water is a possibility. Never spill liquid of any kind onto the tool.

6. Storage

Do not use or store the tool in an area where it is exposed to direct sunlight or excessive moisture.

7. Usage

To reduce the risk of fire, do not operate the tool in the vicinity of open containers or flammable liquids. Do not use if the potential for explosive gas or vapors exists. Keep the tool away from heat generating sources. Do not operate the tool with the battery cover removed.

4. TP-47 Overview





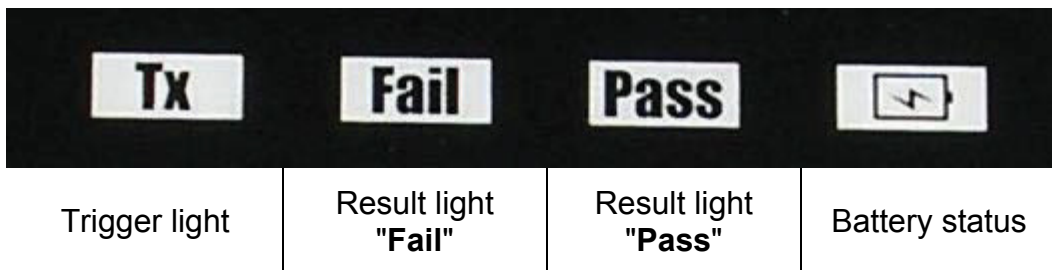





4.1. LIGHTS



4.2. CONNECTORS



5. FUNCTION KEYS

 Power ON/OFF switch	 Test or trigger sensor.
 Next, continue or confirm.	 Cancel, previous step.
 Navigate to select "up".	 Navigate to select "down".
 Navigate to select "left".	 Navigate to select "right".



6. POWER ON

Press  key to turn on device, the **TPMS TOOL**

- Version # and Region will be displayed



Fig. 2

- The **MAIN MENU** will then be displayed as Fig. 2

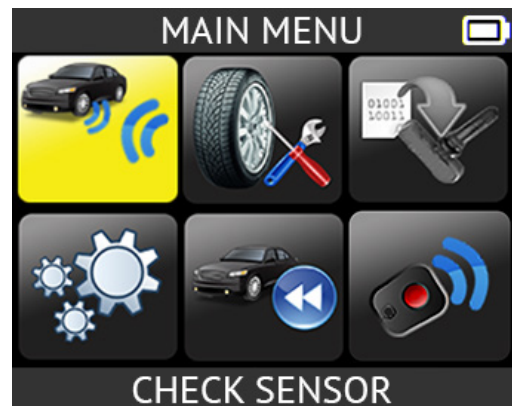

7. OPERATING INSTRUCTIONS

7.1. TPMS TOOL OVERVIEW

Read and diagnose sensors, and reset TPMS.



Note: With most vehicles, if the vehicle is in “learn mode” the vehicle will also confirm that the TPM sensor has communicated to the ECM with a series of horn beeps.

Service Procedure

Section 1.0: Check Sensor

Before servicing the tires/wheels, using your **TPMS TOOL**, trigger each of the vehicle's sensors to make sure they are working properly.

This will eliminate the liability associated with replacing previously damaged or defective sensors. This procedure will not change the vehicle settings because the vehicle has yet to be put into learn/retraining mode.

This procedure allows you to quickly identify damaged or defective sensors, because some vehicles do not report a damaged or defective sensor condition on the instrument cluster for up to 20 minutes.

Note: If the sensors do not trigger, please refer to the Troubleshooting section of this Guide.

Perform tire/wheel service.

For vehicles that require retraining, please see to Section 2.0

Section 2.0: Service

With the vehicle in learn mode, begin by triggering the driver's front left (LF) wheel sensor. Many vehicles will provide an audible beep confirming that the sensor ID has been learned by the vehicle on board computer.

The communication between the sensor and the on board computer is also confirmed on LCD display of the **TOOL**.

The same procedure should be followed on all wheel sensors, in a clockwise rotation, until all the vehicle sensors have been retrained.

After triggering the driver's rear wheel sensor, some vehicles will beep twice, indicating that the TPM system has been retrained.

For vehicles that do not require retraining, we recommend you trigger each wheel sensor, one final time, to make sure they are working correctly prior to releasing the vehicle to the customer.

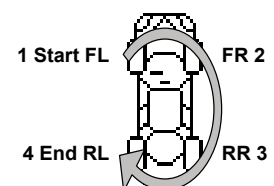
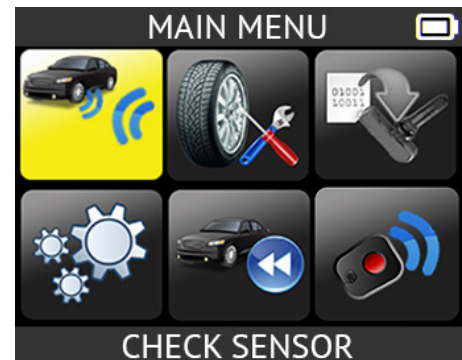
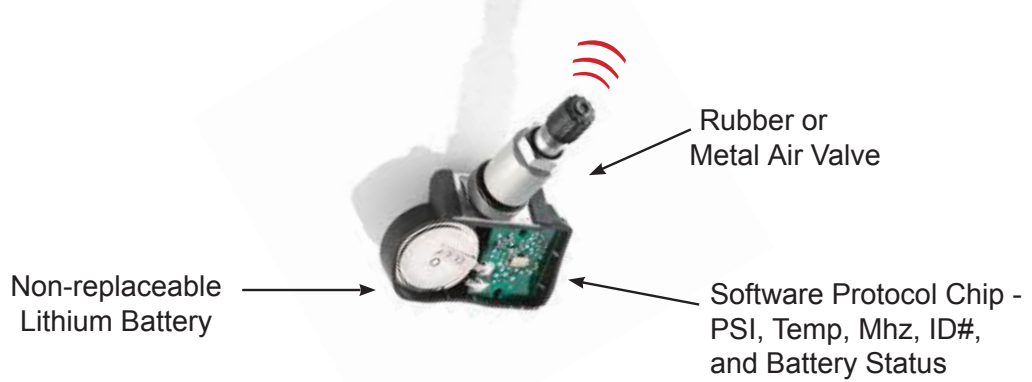
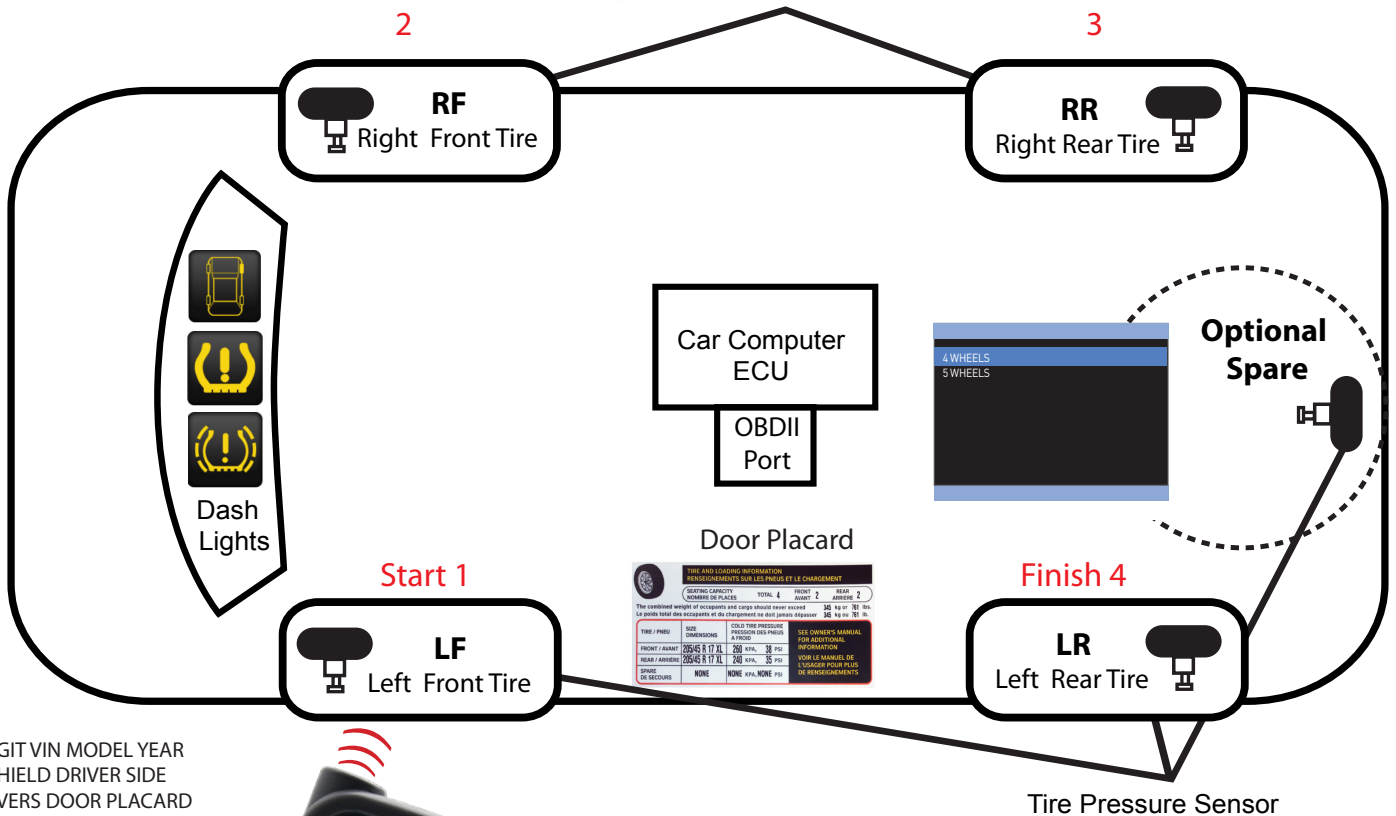

Fig. 5

DIRECT TIRE PRESSURE MONITORING SYSTEM



Tire Pressure Sensor Components



10TH DIGIT VIN MODEL YEAR
WINDSHIELD DRIVER SIDE
OR DRIVERS DOOR PLACARD

- 2002 2
- 2003 3
- 2004 4
- 2005 5
- 2006 6
- 2007 7
- 2008 8
- 2009 9
- 2010 A
- 2011 B
- 2012 C
- 2013 D
- 2014 E
- 2015 F
- 2016 G
- 2017 H



TIRE PRESSURE MONITORING TECHNICIAN GLOSSARY

- 1. ACTIVATE**-A LOW FREQUENCY (LF) WIRELESS SIGNAL IS SENT THROUGH TOOL ANTENNA TO THE SENSOR INSIDE THE TIRE. THIS ALLOWS TECHNICIAN TO READ TIRE PRESSURE, ID NUMBER, TEMP AND BATTERY STATUS WITHOUT DRIVING THE VEHICLE.
- 2. AFTERMARKET SENSOR**-REPLACEMENT SENSORS SUPPLIED BY LOCAL AUTO PARTS STORES OR TIRE SUPPLIERS. THE SENSOR MAY NOT PHYSICALLY LOOK LIKE THE OE SENSOR.
YOUR TOOL HAS SPECIAL PROGRAMMING SOFTWARE BASED ON THE SPECIFIC SENSOR BRAND.
- 3. AUTO RELEARN**-SENSOR ID NUMBERS ARE SENT TO THE ECU AFTER DRIVING THE VEHICLE FOR A SPECIFIED TIME. YOUR TOOL WILL INDICATE THE REQUIRED DRIVING TIME UNDER SERVICE TPMS ICON.
- 4. BATTERY LIFE**-SENSORS HAVE AN INTERNAL LITHIUM ION BATTERY WHICH CAN NOT BE REPLACED. TYPICAL LIFE IS SOMEWHERE BETWEEN 5-10 YEARS. YOUR TOOL WILL DISPLAY NO SENSOR DETECTED ON THE SCREEN IF SENSOR BATTERY HAS FAILED. A DTC CAN BE SET IN THE ECU ALSO.
- 5. CLONEABLE OR CLONING**-USED ONLY BY AFTERMARKET SENSOR BRANDS TO COPY THE ID NUMBER AND COMMONLY SKIP THE RELEARN PROCEDURE. NOT RECOMMENDED BY OE VEHICLE MANUFACTURER. ALWAYS RELEARN THE TPM SYSTEM WHEN CHANGING A SENSOR.
- 6. CROSS TALK**-WHEN THE TPMS TOOL SIGNAL GETS CONFUSED BY ANOTHER SENSOR SIGNAL. EXAMPLE: YOU HAVE REPLACE AN OLD SENSOR BUT IT IS IN CLOSE PROXIMITY DURING YOUR RELEARN THE NEW SENSOR. THE OLD SENSOR SHOULD BE REMOVED FROM THE SERVICE BAY AS IT MAYBE TRANSMITTING
- 7. DELTA PRESSURE**-A RAPID CHANGE IN TIRE PRESSURE UP OR DOWN AS AN ALTERNATIVE METHOD TO LF WHICH ACTIVATES THE SENSOR. REFER TO SERVICE MANUAL AS WELL AS TOOL ON SCREEN INSTRUCTIONS. COMMON ON GM PRIOR TO 2009 AND MANY EUROPEAN SYSTEMS.
- 8. DIAGNOSTIC TROUBLE CODE(DTC)**-SIMILAR TO CHECK ENGINE LIGHT BUT CODES ARE SPECIFIC TO TPMS
- 9. DIRECT SYSTEM**-MOST COMMON DESIGN USED BY MAJORITY OE'S. 4 TO 6 TPM SENSORS WITH VALVES MOUNTED INSIDE THE TIRE. VALVES MAYBE RUBBER OR METAL DESIGN AND IT IS IMPORTANT TO SERVICE THE REPLACEABLE PARTS. BE CAREFUL SOME VEHICLE MAY USE DIRECT AND INDIRECT DEPENDING ON THE MODEL. YOUR TOOL SCREEN WILL SHOW INDIRECT UNDER SERVICE ICON EVEN THOUGH NO PHYSICAL TPM SENSOR INSIDE THE TIRE.
- 10. HIGH LINE**-THE VEHICLE DASH WILL DISPLAY TIRE PRESSURE BY WHEEL LOCATION. ALSO CALL ADVANCED SYSTEM. MANY LUXURY VEHICLES SHOW PRESSURE AND TEMPERATURE. SOME VEHICLE MANUFACTURERS OFF UPGRADE ACCESSORY OPTIONS INCLUDING HIGH LINE. EXAMPLE: 2015/2016 TOYOTA CAMRY IS STANDARD WITH LO LINE BUT OPTIONAL COLORED DASH DISPLAY WILL BE A HI LINE. SELECT CORRECT SYSTEM WHEN ORDERING REPLACEMENT SENSOR PART NUMBER.
- 11. HYBRID SENSOR**-A TYPE OF PROGRAMMABLE AFTERMARKET SENSORS. THE TECHNICIAN SELECTS MAKE/MODEL AND YEAR AND TRIGGERS ACTIVATION WITH THE TPMS TOOL IN 1-3 SECONDS. EXAMPLE: HAMATON U-Pro
- 12. ID NUMBER**-A SPECIFIC DECIMAL OR HEXADECIMAL NUMERIC NUMBER ASSIGNED TO EACH SENSOR. THIS ALLOWS ECU TO SEE SPECIFIC TIRE LOCATION BY EACH SENSOR FOR RESETTING OR RELEARNING THE TPM SYSTEM. IN MANY CASES PHYSICALLY PRINTED ON SENSOR BODY BUT NO EASY TO READ. YOUR TOOL WILL DISPLAY THE SENSOR ID NUMBER.
- 13. INDIRECT SYSTEM**-THIS DESIGN DOES NOT HAVE A PHYSICAL SENSOR W/VALVE INSIDE THE TIRE. INSTEAD IT CALCULATES LOW PRESSURE FROM THE (ABS) ANTI-LOCK BRAKE SYSTEM WHEEL SPEED SENSOR. RESET INSTRUCTIONS ARE IN YOUR TOOL WHEN ADJUSTING AIR PRESSURE. HOWEVER, A FULL FUNCTION DIAGNOSTIC SCAN TOOL WITH GRAPHING IS REQUIRED TO DIAGNOSE ABS WHEEL SPEED SENSORS.
- 14. LEARN MODE**-THE VEHICLE'S RECEIVER AND ECU ARE ACTIVATED TO PICK UP THE WIRELESS SIGNAL BEING TRANSMITTED FROM THE SENSOR INSIDE THE TIRE (DIRECT SYSTEM) YOUR TPMS TOOL WILL SHOW VARIOUS INSTRUCTIONS SUCH AS USING A KEY FOB, CYCLING IGNITION SWITCH, PRESSING BRAKE PEDAL, ETC. DEPENDING ON VEHICLE MAKE/MODEL AND YEAR. SPARE TIRE MAY HAVE A FUNCTIONING SENSOR AND CAN BE INCLUDED IN LEARN MODE.
- 15. LOW LINE-SYSTEM** DO NOT SHOW PRESSURE BY WHEEL LOCATION JUST A SYMBOL INDICATING LOW PRESSURE ON ONE OF THE TIRES. LOW LINE SENSORS SHOULD NOT BE USED ON HIGH SYSTEMS. EXAMPLE: HYUNDIA GENESIS COUPES ARE LO LINE BUT GENESIS SEDANS ARE HI LINE.

TIRE PRESSURE MONITORING TECHNICIAN GLOSSARY

16. **MALFUNCTION INDICATOR LAMP (MIL)**- A LIGHT THAT ILLUMINATES ON THE VEHICLE'S DASH WHEN THE TPM SYSTEM IS SEEING AN ISSUE. SOLID LIGHT INDICATES PRESSURE LOWER THAN THE OE VEHICLE MANUFACTURER RECOMMENDS. A RELEARN OR RESET IS REQUIRED TO TURN THE LIGHT OFF. FLASHING LIGHT INDICATE COMPONENT ISSUES.
17. **MULTI-APPLICATION SENSOR**-AFTERMARKET SENSORS THAT ARE PRE-PROGRAMMED WITH A VARIETY OF MANUFACTURER PROTOCOLS ON THE SENSOR CHIP. FOLLOW OE MAKE,MODEL AND YEAR RE LEARN PROCEDURES WHEN INSTALLING THESE SENSORS.
18. **OBDII TPMS**- USING A STAND ALONE TPMS TOOL OR DIAGNOSTIC SCAN TOOL CAPTURE ID NUMBERS TO TRANSMIT TO THE VEHICLE ECU VIA THE OBDII PORT. COMMON ON JAPANESE AND KOREAN MODELS. CAN BE USED ON SELECT DOMESTIC VEHICLES TO ALSO PUT VEHICLE INTO LEARN MODE.
19. **OE SENSORS**-PRE-PROGRAMMED WITH SINGLE SOFTWARE PROTOCOL.
20. **PLACARD**-A DECAL ON INSIDE OF THE VEHICLE DRIVERS DOOR WITH RECOMMENDED AIR PRESSURE AND TIRE SIZE. REQUIRED BY TREAD ACT FOR ALL MANUFACTURERS
21. **PROGRAMMABLE SENSOR**-A BLANK TPM SENSOR SUPPLIED BY AFTERMARKET PARTS COMPANIES. BRAND NAME EXAMPLES: EZ SENSOR, QWIK SENSOR, SENS IT, UPRO, ETC. TECHNICIAN MUST PROGRAM THE CORRECT MAKE/MODEL/YEAR SOFTWARE PROTOCOL FROM THE TPMS TOOL. CREATE ID OR COPY ID INSTRUCTIONS WILL BE SHOWN ON THE TOOL.
22. **PROTOCOL**-THE SPECIFIC OE SOFTWARE INSIDE THE SENSOR CHIP THAT IS REQUIRED TO MATCH THE MANUFACTURER MAKE/MODEL AND YEAR.
23. **RADIO FREQUENCY (RF)**-THE RADIO WAVE SPECIFIED BY FCC FOR CAR MANUFACTURERS TIRE PRESSURE MONITORING SYSTEMS IN NORTH AMERICA. SERVICE AND PARTS CATALOGS WILL INDICATE 314.9,315, 433.92, OR 434 MHZ. THESE NUMBERS CAN ALSO BE PRINTED ON SENSOR BODY. YOUR TPMS TOOL WILL ALSO SHOW FREQUENCY MHZ.
24. **ROLLING MODE**-SENSORS GENERALLY SAMPLES DATA EVERY 60 SECONDS WHEN VEHICLE IS IN MOTION AND MAINTAINS A MINIMUM SPEED.
25. **SERVICE KITS**-TPMS VALVE COMPONENTS SUCH AS GASKETS, GROMMETS, SEALS, VALVE CORES, SCREWS AND CAPS NEED TO BE SERVICED DURING TIRE CHANGES. REMEMBER THE VALVE IS IMPORTANT TO ENSURING TIRE PRESSURE IS MAINTAINED FOR SAFETY AND FUEL ECONOMY.
26. **SLEEP MODE**-SENSOR BATTERIES LIFE IS CONSERVED DURING PERIODS OF TIME VEHICLES ARE NOT BEING USED. EXAMPLE: SHIPMENT TO THE NEW CAR DEALER. THIS MAY VARY BY MANUFACTURER AND ANOTHER TERM IS STORAGE MODE.
27. **STATIONARY RELEARN** MODE-A TERM USED WHEN THE VEHICLE IS NOT BEING DRIVEN. EXAMPLE: A VEHICLE IS IN YOUR SERVICE BAY OVERNIGHT. THE TRANSMISSION OF SENSOR INFORMATION HAS BEEN REDUCED TO SAY BATTERY LIFE. NOT EVERY OE USES THE SAME METHOD.
28. **TREAD ACT**-THE US FEDERAL LAW THAT MANDATED ALL VEHICLES UNDER 10,000 LBS HAVE A TPMS SYSTEM AFTER 2007. MANY VEHICLES BEFORE 2007 HAVE TPMS.
29. **TRIGGER TOOL**-A GENERIC TERM USED FOR ANY HAND HELD TOOL WITH OR WITHOUT A DISPLAY TO ACTIVATE A DIRECT TPM SENSOR BY (LF) LOW FREQUENCY WIRELESS SIGNAL. ALSO CALLED ACTIVATION OR EXICTER TOOL.
30. **UNIVERSAL SENSOR**-AN AFTERMARKET PARTS TERM USED TO DESCRIBE A SENSOR THAT CAN WORK ON MORE THAN A SINGLE MAKE/MODEL AND YEAR.
31. **VEHICLE PROGRAMMING**-SOMETIMES USED IN PLACE OF TERM RELEARN OR RESET THE LIGHT
32. **VEHICLE RELEARNING**-THE STEPS SHOWN ON THE TPMS TOOL FOR THE TECHNICIAN TO FOLLOW WHEN AD JUSTING TIRE PRESSURE, ROTATING TIRES OR REPLACING A TPM SENSOR. THEY FALL INTO THREE TYPES-AUTO RELEARN, STATIONARY OR OBDII
33. **WIRELESS AUTO LOCATE (WAL)** SYSTEMS SHOW PRESSURE BY TIRE LOCATION. AFTERMARKET SENSOR SUPPLIERS OFTEN LIST A SECOND PART NUMBER TO COVER WAL APPLICATIONS. WAL USED ON - CHRYSLERS, JEEPS AND MERCEDES VEHICLES WHERE SCHRADER IS OE SUPPLIER. USING INCORRECT PART NUMBER CAN RESULT IN TPMS DASH LIGHT TURNING ON EVEN WHEN TIRE PRESSURE IS CORRECT.

FOR ADDITIONAL ON LINE TPMS TECHNICIAN TRAINING COURSES PLEASE GO TO **WWW.TIREINDUSTRY.ORG**

TP-47 TPMS TOOL

IMPORTANT:

Vehicle specific information in this manual is used as an example and may not represent specific instructions each make and model may require. When performing various functions with the tool, it is important to refer to the on-screen prompts and/or repair manual information.

1. CHECK SENSOR

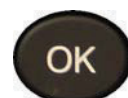

= continue



= Previous

1.1. SELECT CAR MANUFACTURER

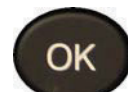
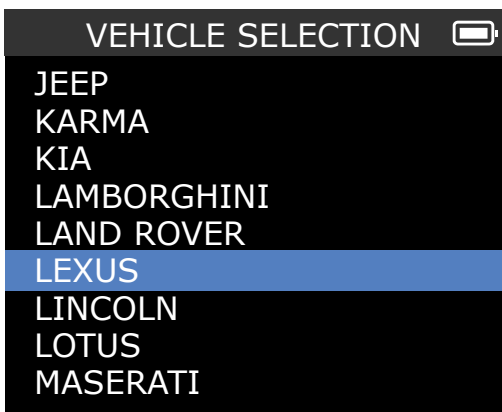

= continue



= Previous

1.2. SELECT CAR MODEL

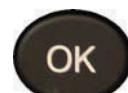
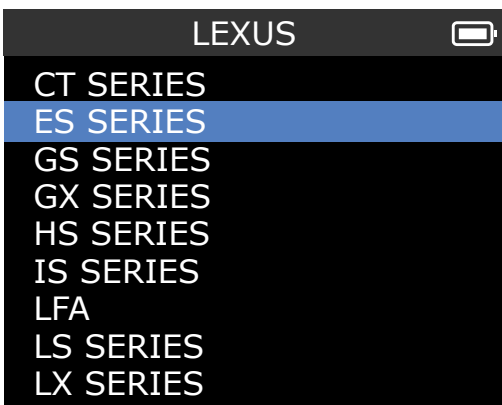

= continue



= Previous

Check Sensor

1.3. SELECT YEAR

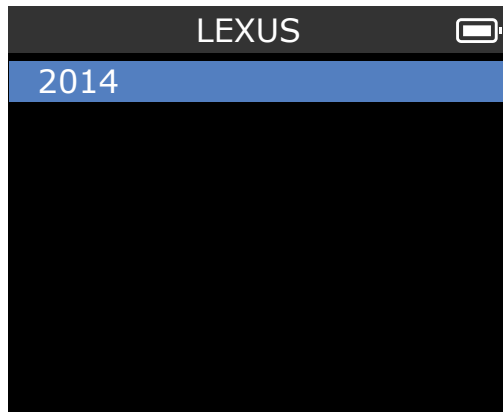

= continue



= Previous

1.4. SELECT WHEEL NUMBER

This option does not appear for all vehicles.

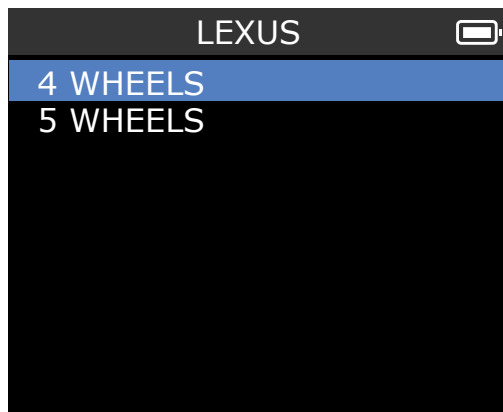

= continue



= Previous

1.5. TEST SENSORS (TRIGGER)

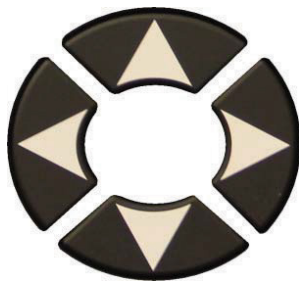

Select tire.



= continue



= Previous

1.6. CHECK SENSOR

To change tire



RIGHT FRONT



RIGHT REAR



LEFT REAR

The tool is triggering the sensor.

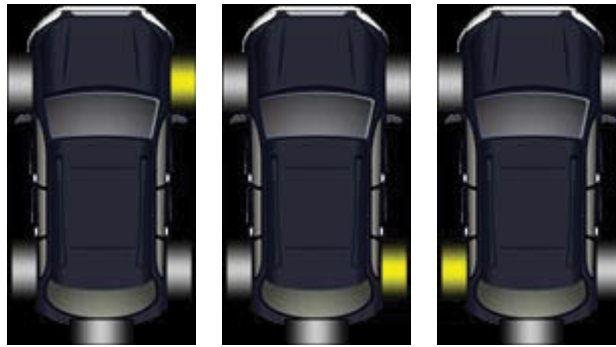

Pass

Pass

Pass

Trigger all wheels.



= Continue



= Previous and erase results

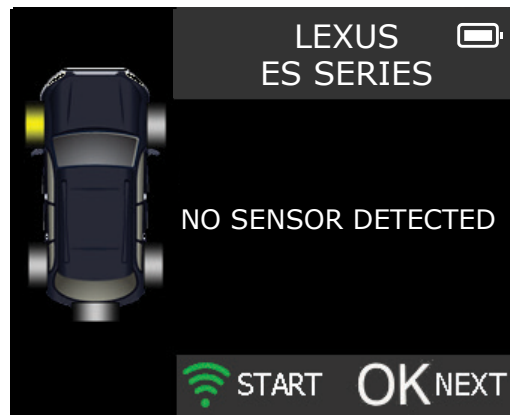

Fail

The tool does not detect a sensor

Possible Reasons

1. Tool Antenna is not positioned correctly on tire
2. Sensor battery has expired
3. Wrong sensor part number was installed
4. Technician has removed sensor from the tire
5. Aftermarket sensor was not programmed with tool
6. Indirect system works off ABS wheel sensor speed

2. SERVICE TPMS

Servicing TPM System to ensure the dash light is not illuminated maybe required when adding air, rotating tires, or replacing a sensor.

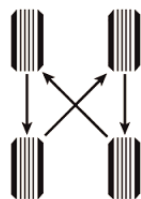
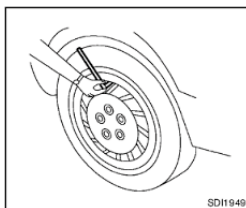

2.1 SERVICE TPMS-P/N LOOK-UP

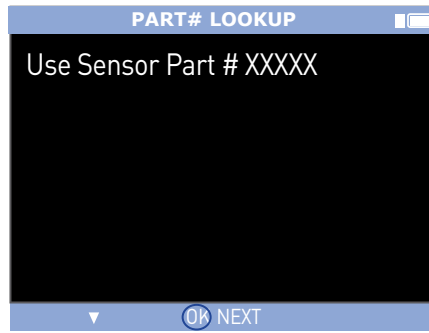

This section details how to relearn the sensor to the ECU.



Select "**SERVICE TPMS**" menu.

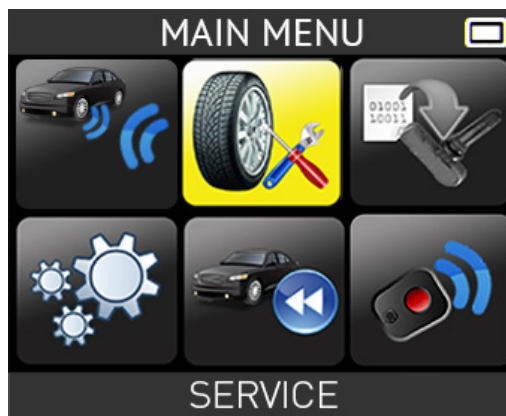

OK
= continue
C
= Previous

- Select car manufacturer.
- Select car model.
- Select year.

2.2 AUTO RELEARN SYSTEMS

(Acura, Select Hondas, Jaguar, Land Rover, Volvo, Chrysler, Dodge and Jeep Brands)

Check tire pressure with TPMS Tool VS door placard and drive the vehicle.

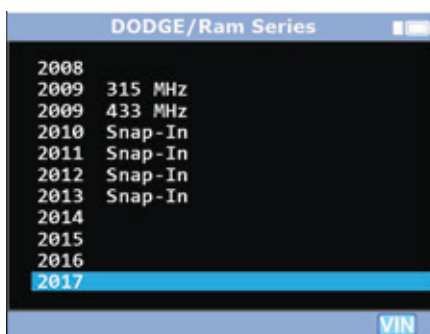

2.3 SERVICE TPMS

MANUAL OR STATIONARY RELEARN SYSTEMS

(General Motors, Ford, BMW, ,Mini, and Porsche)

Use Tool and follow instructions on the screen.

1

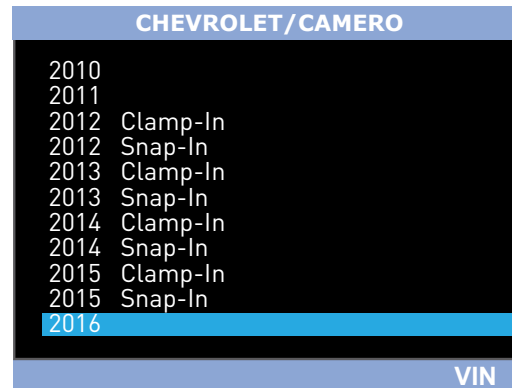

2

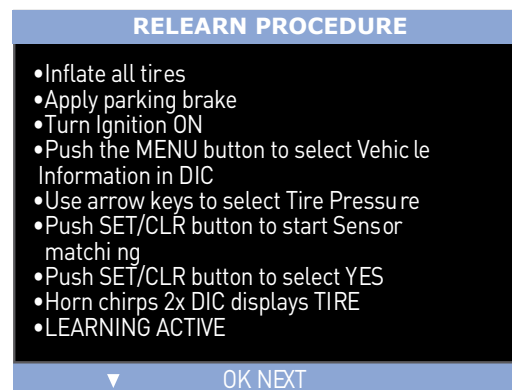

3

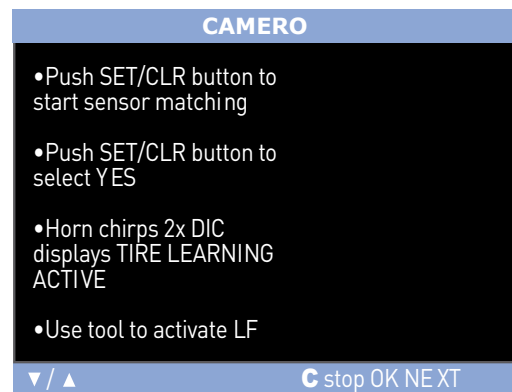

4

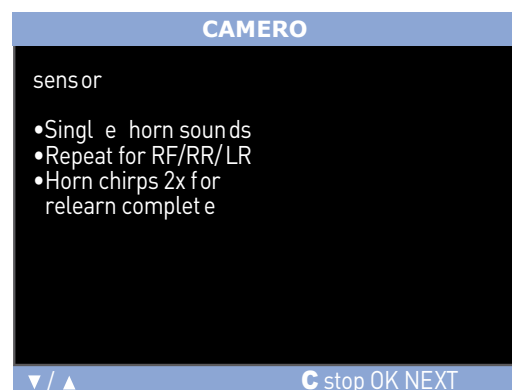

3. PROGRAM SENSOR

This section is to recover a sensor ID in order to enter it in the spare blank sensor. If the "old" sensor can be read, use the **"COPY ORIGINAL SENSOR"** section to recover the ID. If it cannot be read, use the **"CREATE NEW SENSOR"** section to create a randomized ID.

This section details how to relearn the sensor to the ECU with the OBD-II port or to have the part # lookup for all the sensors available for the vehicle.

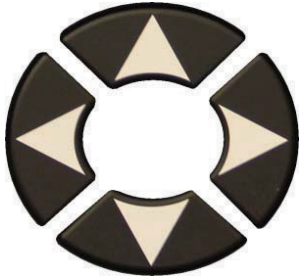

Select
"PROGRAM SENSOR"
menu.

- Select car manufacturer.
- Select car model.
- Select year.



OK
= continue

C
= Previous

Note: You may have to choose a generation of sensors

3.2. "COPY ORIGINAL SENSOR" SECTION

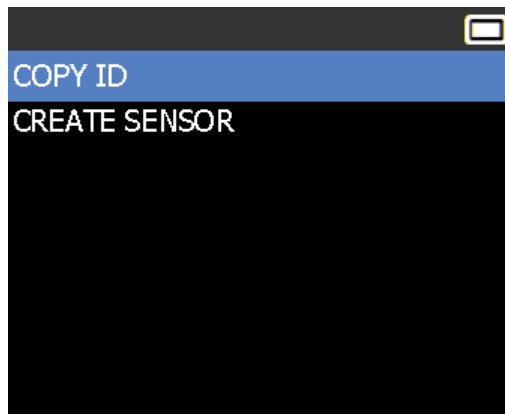

= continue



= Previous

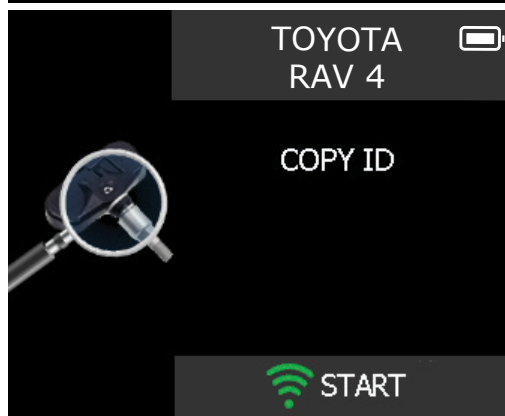

To trigger the original sensor

Wait a few seconds.

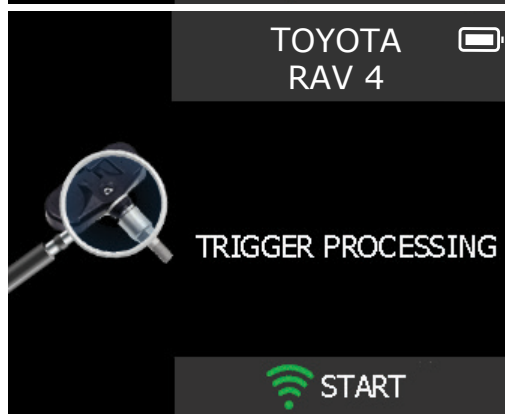

ID of the old sensor is displayed.

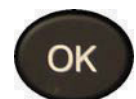

= continue



= Previous

Hold the new programmable sensor near the device antenna.

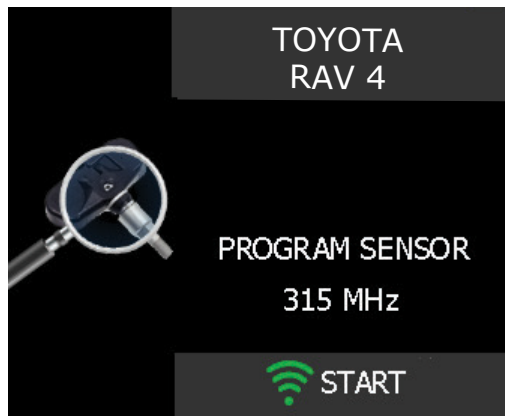

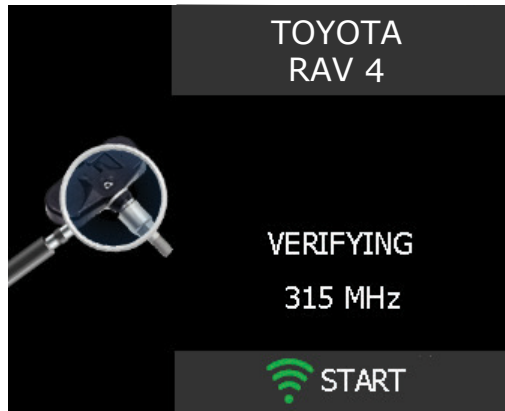

To upload data to the blank sensor.

Wait a few seconds.



The data is successfully uploaded to the sensor.



= continue

Example of Sensor ID # on body

ID# F9199D



Pacific Style Sensor

Acura, Honda, Infiniti,
Lexus, Nissan, Pontiac,
Scion, Toyota

3.3. "CREATE NEW SENSOR SECTION

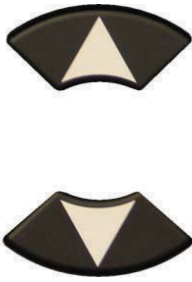

Hold the new programmable sensor near the device antenna.

Wait a few seconds.

The data is successfully uploaded to the sensor.

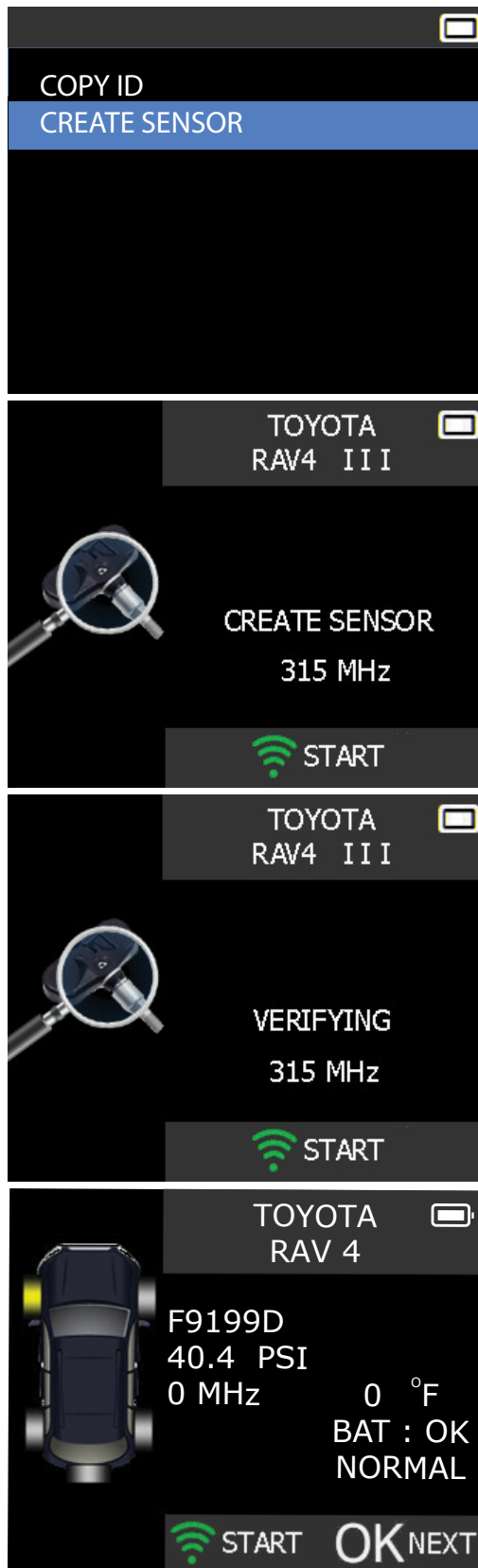

= continue



= Previous



To upload data to the blank sensor.



= continue

KEYFOB

1. ENTER KEYFOB MENU



Select "KEYFOB" menu.



- Select car manufacturer.
- Select Fob Frequency.



= continue



= Previous

Press the trigger button to test for Keyfob signal strength and battery status.

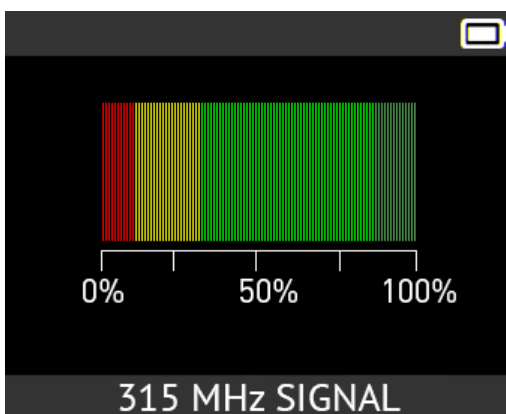

= Trigger



= continue



= Previous

1.1. CHANGE REGION SETTINGS



Scroll up and down to select the zone menu.



Scroll up and down to select a zone.

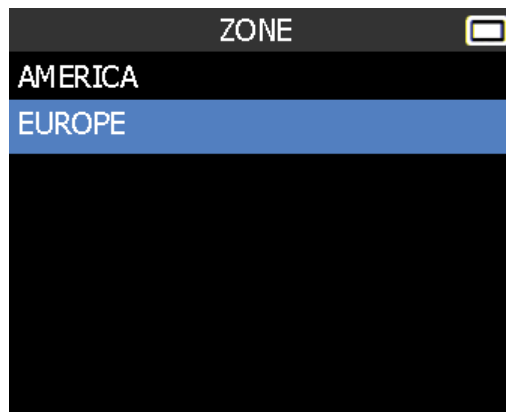
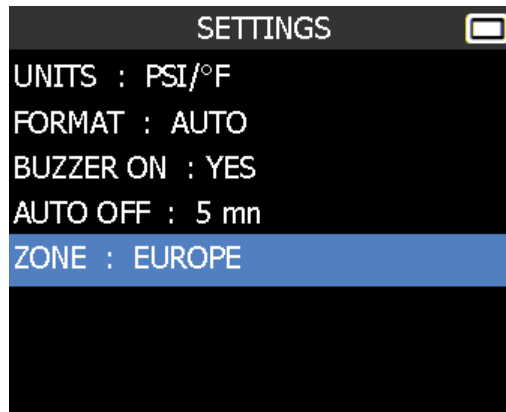

= Confirm



= Previous



= Confirm



= Previous

The tool will load the new database for the selected zone.

1.2. CHANGE UNITS SETTINGS



Scroll up and down to select function or settings.



Scroll up and down to select the units.

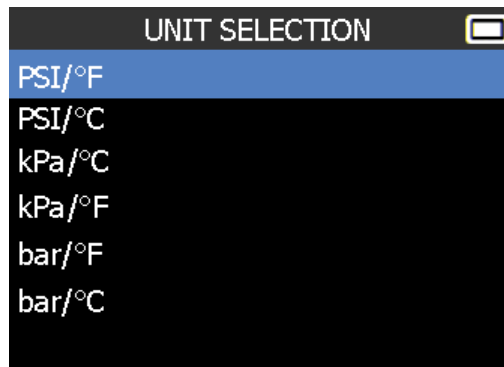
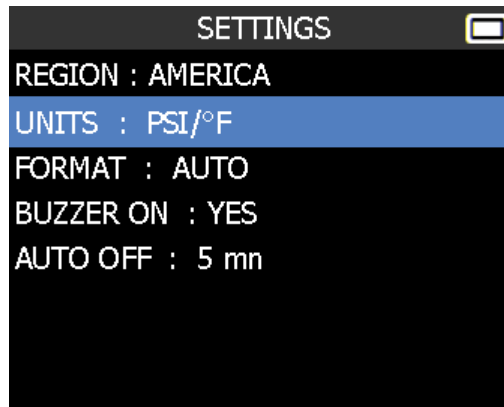

= continue



= Previous



= continue



= Previous

1.3. CHANGE FORMAT SETTINGS



Scroll up and down to select function or settings.



Scroll up and down to select the format.

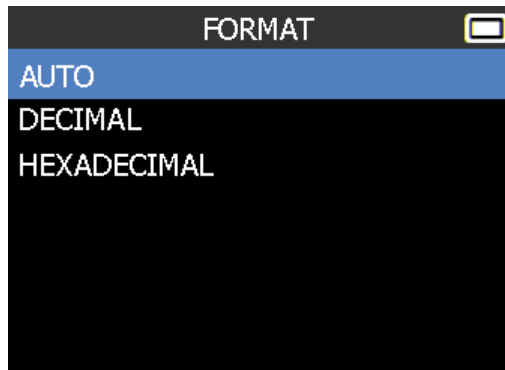
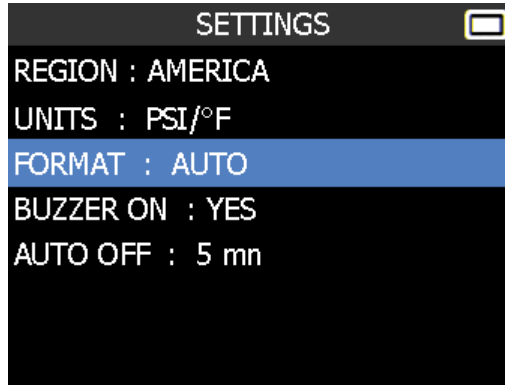

= continue



= Previous



= continue



= Previous

AUTO: display sensor ID format in the way sensor is transmitting.

DECIMAL: force to display sensor ID in decimal (0 to 9).

HEXADECIMAL: force to display sensor ID in hexadecimal (0 to F).

1.4. CHANGE BUZZER ON SETTINGS

When buzzer on is set to **YES**, a beep is triggered when the sensor ID is detected.



Scroll up and down to select function or settings.

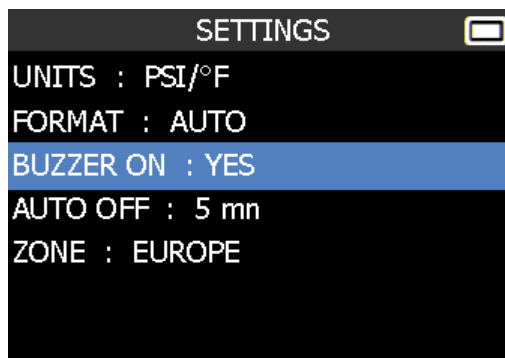

= continue



= Previous

1.5. CHANGE AUTO OFF SETTINGS



Scroll up and down to select function or settings.

The selection turns red.



Scroll up and down to set the time.

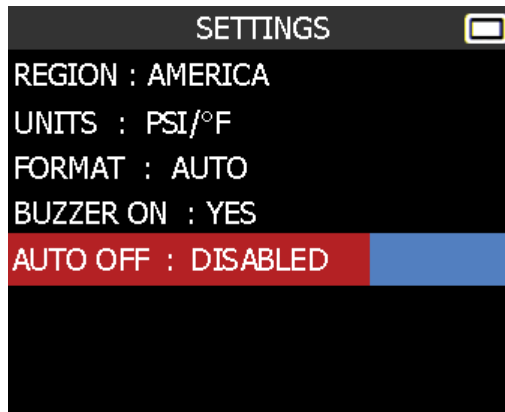
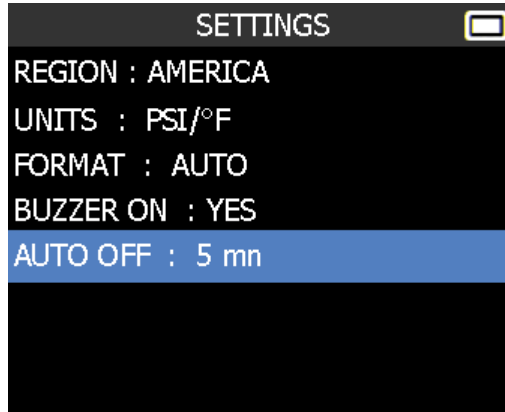

= continue



= Previous



= continue



= Previous

Change by **60 min** (maximum) to **DISABLED** (never).

ABOUT

1. ENTER THE SETTINGS MENU

This menu displays the current version and information about the device.

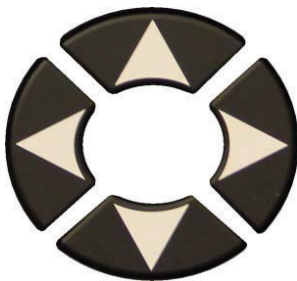

Select the **ABOUT**

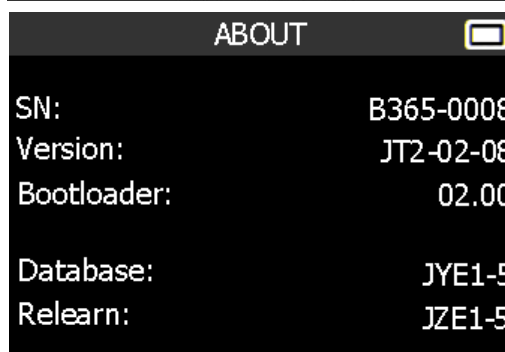
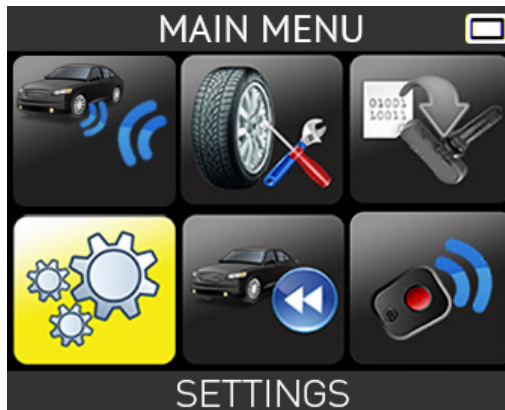

= continue



= Previous



= Previous



= Previous

MISCELLANEOUS

1. CHARGE

Low Battery Indication

Your **TPMS TOOL** incorporates a low battery detection circuit. Battery life is an average of 300 sensor tests per battery charge (approximately 60 to 80 vehicles) this may change depending on the sensor model.

Battery indicator status:

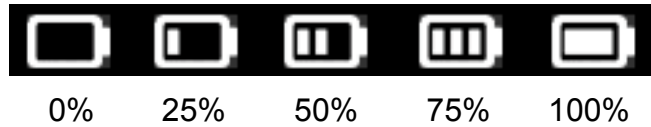

When 0% is flashing, the tool will turn off after 10 seconds.



The battery is charging.



There is an issue with the battery - please contact after sales service.

DO NOT use the tool with low battery status because the transmission and emission may not be reliable.

When charging, the battery light is red and becomes green when the battery is fully charged.



USB Power
supply connector

Fig. 6

When the battery is low, the “status bar” appears every 10 seconds. This display will stop when the battery loses power.

Plug the USB cable between the tool and the charger adapter, and then plug the charger adapter into an appropriate outlet. The red LED "**CHARGE**" light will turn on.

Battery replacement

The tool must be returned to the factory for battery replacement.

Opening the tool or tampering with the seal placed on the tool, if broken, will void the warranty

SETTINGS

1. ENTER SETTINGS MENU



Select **SETTINGS**



Scroll up and down to
select function or settings.

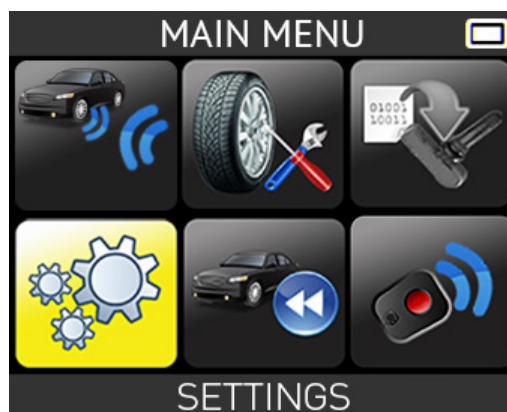

= continue



= Previous

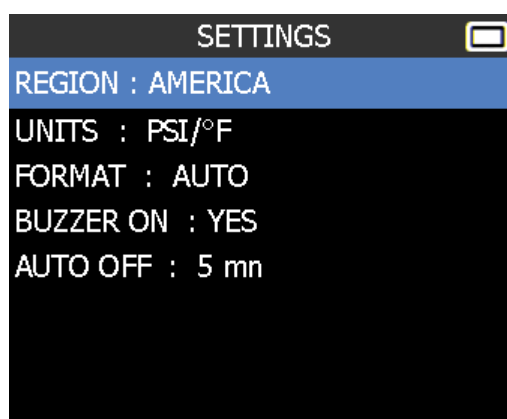

= continue



= Previous

Key functional descriptions:

REGION: to select the area of work, select REGION . Be careful, when you change the zone, a WebVT download or SD card is required to get the zone data.

UNITS: change the air pressure and temperature display (kPa, Bar or PSI with F° or C°).

FORMAT: change the format of sensor ID display.

BUZZER: turn buzzer to ON or OFF (YES or NO).

AUTO OFF: time to turn off the device automatically after not being operated.

MISCELLANEOUS

1. CHARGE

Low Battery Indication

Your **TPMS TOOL** incorporates a low battery detection circuit. Battery life is an average of 300 sensor tests per battery charge (approximately 60 to 80 vehicles) this may change depending on the sensor model.

Battery indicator status:

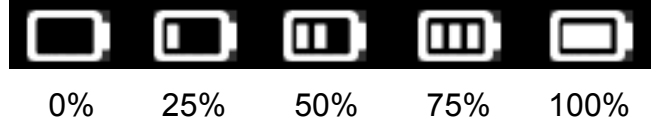

When 0% is flashing, the tool will turn off after 10 seconds.



The battery is charging.



There is an issue with the battery - please contact after sales service.

DO NOT use the tool with low battery status because the transmission and emission may not be reliable.

When charging, the battery light is red and becomes green when the battery is fully charged.

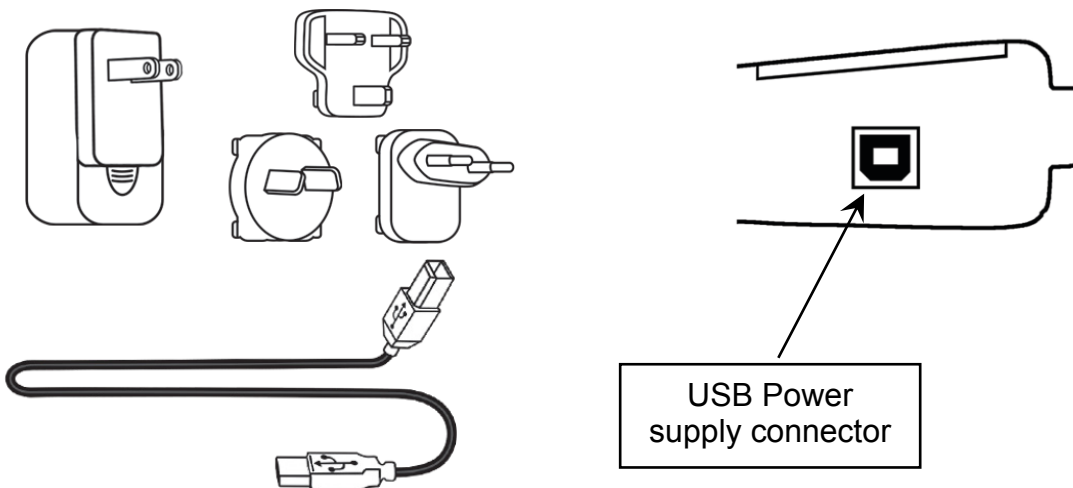
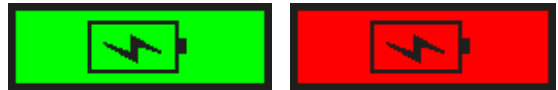

When the battery is low, the “status bar” appears every 10 seconds. This display will stop when the battery loses power.

Plug the USB cable between the tool and the power charger, and then plug the charger into an appropriate outlet. The red LED "**CHARGE**" light will turn on.

Battery replacement

If the battery is defective, the tool must be returned to the after sales service for battery replacement.

Opening the tool or tampering with the seal placed on the tool, if broken, will void the warranty

2. TOOL UPDATE

Updating the TPMS TOOL

When a new protocol becomes available, it is necessary to update your tool. Please follow the steps below:

IMPORTANT: Temporarily turn off all anti-virus and spam blocking software on your computer. This is necessary to ensure a successful upgrade.

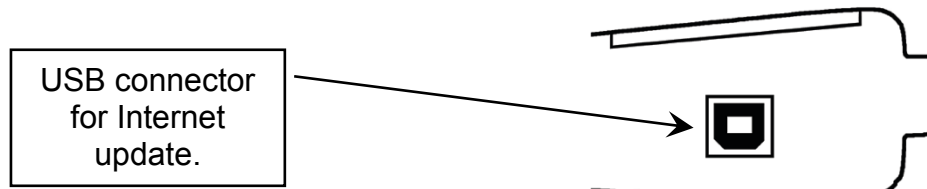

Fig. 1

Install WebVT PC Suite

- 1) Connect the TPMS tool to the USB port and power the tool ON.
- 2) Go to www.topdonusa.com to download the pc software.
- 3) Click on the **WebVT** icon to start the program.
- 4) A screen will appear that says, "Welcome to the Install Shield Wizard for WebVT." Click "Next >"
- 5) A window will appear for choosing the destination location, click "Next >"
- 6) Follow the instructions until the window with the "Finish" button appears.
- 7) Click "Finish" when the **WebVT** installation is complete.

Note: To order annual update software part numbers, please see your dealer for availability and pricing.

Update the tool software

Before updating, ensure that the battery is fully charged.

- 1) Connect the USB cable from the **TPMS TOOL** to the **PC** and turn the device on.
- 2) Start **WebVT** software.
- 3) A screen will appear indicating "Update Device".
- 4) Press "Yes" to update to the latest software version. The update will take several minutes to complete, and the status bar will indicate the percentage of update completed.

Warning!

Turn off the screen saver function on your PC and do not disconnect the TPMS TOOL from the PC or turn off your computer during the update process. Doing so could result in serious damage to the tool

3. LIMITED HARDWARE WARRANTY

TOPDON Limited Hardware Warranty

TOPDON warrants to the original purchaser that your **TOPDON** hardware product shall be free from material and workmanship defects for the length of time identified on your product package and/or contained in your user documentation, from the date of purchase. Except where prohibited by applicable law, this warranty is nontransferable and is limited to the original purchaser. This warranty gives you specific legal rights, and you may also have other rights that vary under local laws.

Remedies

TOPDON entire liability and your exclusive remedy for any breach of warranty shall be to repair or replace the hardware. **TOPDON** may, at its option, use new or refurbished or used parts in good working condition to repair or replace any hardware product. Any replacement hardware product will be warranted for the remainder of the original warranty period or thirty (30) days, whichever is longer or for any additional period of time that may be applicable in your jurisdiction.

This warranty does not cover problems or damage resulting from (1) accident, abuse, misapplication, or any unauthorized repair, modification or disassembly; (2) improper operation or maintenance, usage not in accordance with product instructions or connection to improper voltage supply; or (3) use of consumables, such as replacement batteries, not supplied by **TOPDON** except where such restriction is prohibited by applicable law.

How to Obtain Warranty Support

Before submitting a warranty claim, we recommend you visit the support section at <http://www.sensorcompany.com/> for technical assistance. Valid warranty claims are generally processed through the point of purchase during the first thirty (30) days after purchase; however, this period of time may vary depending on where you purchased your product – please check with **TOPDON** or the retailer where you purchased your product for details. Warranty claims that cannot be processed through the point of purchase and any other

product related questions should be addressed directly to **TOPDON**. The addresses and customer service contact information for **TOPDON** can be found in the documentation accompanying your product and on the web at <http://www.topdonusa.com>

Limitation of Liability

TOPDON SHALL NOT BE LIABLE FOR ANY SPECIAL, INDIRECT, INCIDENTAL OR CONSEQUENTIAL DAMAGES WHATSOEVER, INCLUDING BUT NOT LIMITED TO LOSS OF PROFITS, REVENUE OR DATA (WHETHER DIRECT OR INDIRECT) OR COMMERCIAL LOSS FOR BREACH OF ANY EXPRESS OR IMPLIED WARRANTY ON YOUR PRODUCT EVEN IF **TOPDON** HAS BEEN ADVISED OF THE POSSIBILITY OF SUCH DAMAGES. Some jurisdictions do not allow the exclusion or limitation of special, indirect, incidental or consequential damages, so the above limitation or exclusion may not apply to you.

Duration of Implied Warranties

EXCEPT TO THE EXTENT PROHIBITED BY APPLICABLE LAW, ANY IMPLIED WARRANTY OR CONDITION OF MERCHANTABILITY OR FITNESS ON THIS HARDWARE PRODUCT IS LIMITED IN DURATION TO THE DURATION OF THE APPLICABLE LIMITED WARRANTY PERIOD FOR YOUR PRODUCT. Some jurisdictions do not allow limitations on how long an implied warranty lasts, so the above limitation may not apply to you.

National Statutory Rights

Consumers have legal rights under applicable national legislation governing the sale of consumer goods. Such rights are not affected by the warranties in this Limited Warranty.

No Other Warranties

No **TOPDON** dealer, agent, or employee is authorized to make any modification, extension, or addition to this warranty.

Warranty Periods

The warranty period for **TOPDON** devices is one year.

4. SAFETY BATTERY AND CHARGE INFORMATION

You must read and understand these safety instructions and warnings before using or charging your Lithium-polymer batteries.

Operating environment

Remember to follow any special current regulations any area, and always switch off your device when its use is prohibited or when it may cause interference or danger.

Use the device only in its normal operating positions.

Your device and its enhancements may contain small parts. Keep them out of the reach of small children.

About Charging

Only use the charger supplied with your device. Using another type of charger will result in malfunction and/or danger.

When the red LED turns off, the charge is complete.

About the Charger

Do not use the charger in a high moisture environment. Never touch the charger when your hands or feet are wet.

Allow ventilation around the charger when using it. Do not cover the charger with paper or other objects that will reduce cooling. Do not use the charger while it is inside a carrying case.

Connect the charger to a proper power source. The voltage requirements are found on the product case and/or packaging.

Do not use the charger if the wires become damaged. Do not attempt to service the unit. There are no serviceable parts inside. Replace the unit if it is damaged or exposed to excess moisture.

This charger is not a toy and should not be used by children or infirm persons without proper training or supervision.

Do not use it as a power source.

Unplug it before attempting to service or clean it.

About the Battery

CAUTION: *This unit contains an internal Lithium-polymer battery. The battery can burst*

or explode, releasing hazardous chemicals. To reduce the risk of fire or burns, do not disassemble, crush, pierce or dispose of the battery or the instrument in fire or water, do not short circuit or short the contacts with a metal object.

Use a specified charger approved by the **TOPDON** manufacturer and supplied with the device.

The tool must be returned to the factory for battery replacement.

Opening the tool or tampering with the seal placed on the tool, if broken, will void the warranty

Safety for Lithium-po battery use

NEVER leave the battery unattended during the charging process. The device must imperatively be placed on a non-flammable surface during charging (ceramic platter or metal box).

Charge the Lithium-polymer battery **ONLY** with the charger provided.

NEVER use a Ni-MH (Nickel Metal Hydride) type battery charger to charge a Lithium-polymer battery.

If the battery begins to overheat more than **60°C (140°F)**, **STOP CHARGING IMMEDIATELY**. The battery should **NEVER** exceed **60°C (140°F)** during the charging process.

NEVER charge the battery immediately after use and while still hot. Leave it cool down to ambient temperature.

If you see any smoke or liquid coming from the battery, stop the charge immediately. Disconnect the charger and place the tool in an isolated area for at least 15 minutes. **DO NOT USE THE BATTERY AGAIN**. Return the device to your retailer.

Keep a fire extinguisher for electrical fires handy while charging the battery. In the unlikely event that the Lithium-polymer battery catches fire, **DO NOT** use water to extinguish the fire. Take some sand or use a fire extinguisher as described above.

The Lithium-polymer battery elements must be neutralized to be made unusable. The neutralization process must be performed under strict safety conditions. It is recommended that you return the tool to us. We will extract the battery and give it to a

specialized recycler.

Do not dispose of Lithium-polymer batteries with your general waste.

The Lithium-polymer battery is not suitable for children under 14 years. Keep all Lithium-Ion batteries out of the reach of children

To prevent leakage or other hazards, do not store batteries above **60°C** (140°F). Never leave the battery inside a car (for example) where the temperature could be very high or in a place where temperatures could exceed **60°C** (140°F). Store the battery in a dry place to avoid contact with liquid, whatever the type. Only store the battery on a nonflammable surface, heat resistant, non-conductive and away from all flammable materials or sources. Always store the battery out of the reach of children.

A Lithium-polymer battery should be stored with a minimum charge of 30%. If you store it completely discharged, it will quickly become unusable.

Failure to follow these safety precautions may cause serious personal injury and damage to property. You may even cause a fire!

The **TOPDON** Company disclaims any responsibility for damage sustained in the event of non-compliance with these safety instructions.

Using a Lithium-Ion battery has a high risk of fire and can cause serious damage to property and persons. The user agrees to accept the risk and responsibility.

The **TOPDON** Company is not able to monitor the proper use of the battery with each customer (charge, discharge, storage etc.). It cannot be held responsible for any damage to persons or property.

3. FCC STATEMENTS

Federal Communication Commission Interference Statement

This equipment has been tested and found to comply with the limits for a Class B digital device, pursuant to Part 15 of the FCC Rules. These limits are designed to provide reasonable protection against harmful interference in a residential installation. This equipment generates, uses and can radiate radio frequency energy and, if not installed and used in accordance with the instructions,

may cause harmful interference to radio communications. However, there is no guarantee that interference will not occur in a particular installation. If this equipment does cause harmful interference to radio or television reception, which can be determined by turning the equipment off and on, the user is encouraged to try to correct the interference by one of the following measures:

- Reorient or relocate the receiving antenna.
- Increase the separation between the equipment and receiver.
- Connect the equipment into an outlet on a circuit different from that to which the receiver is connected.
- Consult the dealer or an experienced radio/TV technician for help.

FCC Caution: Any changes or modifications not expressly approved by the party responsible for compliance could void the user's authority to operate this equipment.

This device complies with Part 15 of the FCC Rules. Operation is subject to the following two conditions: (1) This device may not cause harmful interference, and (2) this device must accept any interference received, including interference that may cause undesired operation.

5. CE STATEMENTS

DECLARATION OF CONFORMITY

The manufacturer of the **TPMS TOOL** declares that this device complies with the requirements of:

- ETSI EN 300 330-1 V1.8.1 (2015-03):

Electromagnetic compatibility and Radio spectrum Matters (ERM); Short Range Devices (SRD); Radio equipment in the frequency range 9 kHz to 25 MHz and inductive loop systems in the frequency range 9 kHz to 30 MHz; Part 1: Technical characteristics and test methods.

- ETSI EN 300 330-2 V1.6.1 (2015-03):

Electromagnetic compatibility and Radio spectrum Matters (ERM); Short Range Devices (SRD); Radio equipment in the frequency range 9 kHz to 25 MHz and inductive loop systems in the frequency range 9 kHz to 30 MHz; Part 2: Harmonized EN covering the essential requirements of article 3.2 of the R&TTE Directive.

BS EN 62479:2010:

Assessment of the compliance of low power electronic and electrical equipment with the basic restrictions related to human exposure to electromagnetic fields (10 MHz to 300 GHz).

6. RECYCLING

Do not dispose of the rechargeable Lithium-polymer battery or the tool and/or its accessories in the general waste.



These components must be collected and recycled.



The crossed-out wheeled waste bin means that the product must be taken to separate collection at the end of the product's service life. This applies to your tool and also to any enhancements marked with this symbol. Do not dispose of these products as unsorted municipal waste. For further information, please contact **(TOPDON)**