

Trademarks

Autel®, MaxiSys®, MaxiDAS®, MaxiScan®, MaxiCheck®, and MaxiRecorder® are trademarks of Autel Intelligent Technology Corp., Ltd., registered in China, the United States and other countries. All other marks are trademarks or registered trademarks of their respective holders.

Copyright Information

No part of this manual may be reproduced, stored in a retrieval system or transmitted, in any form or by any means, electronic, mechanical, photocopying, recording, or otherwise without the prior written permission of Autel.

Disclaimer of Warranties and Limitation of Liabilities

All information, specifications and illustrations in this manual are based on the latest information available at the time of printing.

Autel reserves the right to make changes at any time without notice. While information of this manual has been carefully checked for accuracy, no guarantee is given for the completeness and correctness of the contents, including but not limited to the product specifications, functions, and illustrations.

Autel will not be liable for any direct, special, incidental, indirect damages or any economic consequential damages (including the loss of profits).

IMPORTANT

Before operating or maintaining this unit, please read this manual carefully, paying extra attention to the safety warnings and precautions.

For Services and Support

 pro.autel.com
www.autel.com

 1-855-288-3587/1-855-AUTELUS (North America)
0086-755-86147779 (China)

 support@autel.com

For technical assistance in all other markets, please contact your local selling agent.

Safety Information

For your own safety and the safety of others, and to prevent damage to the device and vehicles upon which it is used, it is important that the safety instructions presented throughout this manual be read and understood by all persons operating or coming into contact with the device.

There are various procedures, techniques, tools, and parts for servicing vehicles, as well as in the skill of the person doing the work. Because of the vast number of test applications and variations in the products that can be tested with this equipment, we cannot possibly anticipate or provide advice or safety messages to cover every circumstance. It is the automotive technician's responsibility to be knowledgeable of the system being tested. It is crucial to use proper service methods and test procedures. It is essential to perform tests in an appropriate and acceptable manner that does not endanger your safety, the safety of others in the work area, the device being used, or the vehicle being tested.

Before using the device, always refer to and follow the safety messages and applicable test procedures provided by the manufacturer of the vehicle or equipment being tested. Use the device only as described in this manual. Read, understand, and follow all safety messages and instructions in this manual.

Safety Messages

Safety messages are provided to help prevent personal injury and equipment damage. All safety messages are introduced by a signal word indicating the hazard level.

DANGER

Indicates an imminently hazardous situation which, if not avoided, will result in death or serious injury to the operator or to bystanders.

WARNING

Indicates a potentially hazardous situation which, if not avoided, could result in death or serious injury to the operator or to bystanders.

Safety Instructions

The safety messages herein cover situations Autel is aware of. Autel cannot know, evaluate or advise you as to all of the possible hazards. You must be certain that any condition or service procedure encountered does not jeopardize your personal safety.

 **DANGER**

When an engine is operating, keep the service area WELL VENTILATED or attach a building exhaust removal system to the engine exhaust system. Engines produce carbon monoxide, an odorless, poisonous gas that causes slower reaction time and can lead to serious personal injury or loss of life.

 **SAFETY WARNINGS**

- Wear safety glasses and protective clothing.
- NEVER smoke or allow a spark or flame in the vicinity of an engine.
- Have plenty of fresh water and soap nearby in case battery acid contacts skin, clothing or eyes.
- If battery acid contacts skin or clothing, wash immediately with soap and water. If acid enters eye, immediately flush eye with running cold water for at least ten minutes and get medical attention immediately.
- Use caution when working with metallic tools to prevent sparks or short circuits.
- Remove any jewelry or watches before you start servicing the battery.
- Keep hair, hands, and clothing as well as tester leads and cords away from moving blades and belts.

CONTENTS

SAFETY INFORMATION	ii
SAFETY MESSAGES	ii
SAFETY INSTRUCTIONS	ii
1 USING THIS MANUAL	1
CONVENTIONS	1
2 GENERAL INTRODUCTION	3
2.1 MAXIBAS BT609 TESTER	4
2.1.1 <i>Function Description</i>	4
2.1.2 <i>Power Sources</i>	5
2.1.3 <i>Technical Specifications</i>	6
2.2 MAXIBAS B200 SERIES TESTER	7
2.2.1 <i>Function Description</i>	7
2.2.2 <i>Power Sources</i>	8
2.2.3 <i>Technical Specifications</i>	8
2.3 MAXIVCI V200 — VEHICLE COMMUNICATION INTERFACE (VCI)	9
2.3.1 <i>Function Description</i>	9
2.3.2 <i>Power Sources</i>	10
2.3.3 <i>Technical Specifications</i>	10
2.4 OTHER ACCESSORIES	11
3 GETTING STARTED.....	12
3.1 POWER UP	12
3.1.1 <i>Application Buttons</i>	13
3.1.2 <i>Page Indicator and Navigation Buttons</i>	14
3.1.3 <i>System Status Icons</i>	15
3.2 POWER OFF.....	16
3.3 TEST PREPARATION.....	16
3.3.1 <i>Inspecting the Battery</i>	16
3.3.2 <i>Connecting to a Battery</i>	16
3.4 ESTABLISH VEHICLE COMMUNICATION	17
3.4.1 <i>VCI Connection</i>	17
4 IN-VEHICLE TEST.....	19
4.1 START THE TEST	20
4.2 BATTERY TEST	22
4.3 STARTER TEST.....	24

4.4	GENERATOR TEST	25
5	OUT-VEHICLE TEST	27
5.1	TEST PROCEDURE	27
5.2	TEST RESULTS	28
6	BATTERY REPLACE	29
7	BATTERY RESET	31
7.1	AUTO REGISTRATION (AFTER BATTERY REPLACEMENT)	31
7.2	BMS RESET	32
7.3	ELECTRIC APPLIANCE RESET	32
7.4	SPECIAL FUNCTION	33
7.5	BATTERY USAGE HISTORY	33
8	LITHIUM	35
8.1	LITHIUM-ION BATTERY TEST	35
8.1.1	<i>Visual Inspection</i>	36
8.1.2	<i>Trouble Codes</i>	36
8.1.3	<i>Live Data</i>	37
8.2	ECU INFORMATION	39
8.3	SPECIAL FUNCTION	39
9	DIAGNOSTICS	40
9.1	GETTING STARTED	40
9.1.1	<i>Vehicle Menu Layout</i>	40
9.2	VEHICLE IDENTIFICATION	42
9.2.1	<i>Auto VIN Scan</i>	42
9.2.2	<i>Manual Input</i>	43
9.2.3	<i>Scan VIN</i>	44
9.2.4	<i>Manual Vehicle Selection</i>	44
9.2.5	<i>Alternative Vehicle Identification</i>	45
9.3	DIAGNOSTICS SCREEN LAYOUT	45
9.4	AUTO SCAN	46
9.5	CONTROL UNIT	49
9.5.1	<i>Screen Messages</i>	50
9.5.2	<i>Making Selections</i>	50
9.6	ECU INFORMATION	50
9.7	READ CODES	51
9.8	ERASE CODES	52

9.9 LIVE DATA	53
9.10 ACTIVE TEST.....	59
9.11 GENERIC OBDII OPERATIONS	60
9.11.1 <i>General Procedure</i>	60
9.11.2 <i>Function Descriptions</i>	61
9.12 DIAGNOSTIC REPORT.....	64
9.13 EXIT DIAGNOSTICS	65
10 SERVICE	67
10.1 OIL RESET SERVICE	67
10.2 ELECTRIC PARKING BRAKE (EPB) SERVICE	68
10.3 TIRE PRESSURE MONITORING SYSTEM (TPMS) SERVICE	68
10.4 BATTERY MANAGEMENT SYSTEM (BMS) SERVICE.....	68
10.5 DIESEL PARTICLE FILTER (DPF) SERVICE.....	69
10.6 IMMOBILIZER (IMMO) SERVICE	70
10.7 STEERING ANGLE SENSOR (SAS) SERVICE	70
11 MULTIMETER	72
11.1 SAFETY INFORMATION.....	72
11.2 CONNECTING THE MULTIMETER.....	73
11.3 LEAKAGE DETECTION.....	75
11.3.1 <i>Current Model</i>	75
11.3.2 <i>Multimeter Model</i>	75
11.4 RELATIVE COMPRESSION TEST	76
11.5 BASIC FUNCTION	77
11.5.1 <i>Screen Layout and Operation</i>	77
12 DATA MANAGER	79
12.1 VEHICLE HISTORY	80
12.1.1 <i>Historical Test Records</i>	81
12.2 WORKSHOP INFORMATION	82
12.3 CUSTOMER	82
12.4 IMAGE	83
12.5 PDF FILES	84
12.6 REVIEW DATA	85
12.7 UNINSTALL APPS	85
12.8 DATA LOGGING	85
13 UPDATE	86

14 SETTINGS	88
14.1 UNIT.....	88
14.2 LANGUAGE.....	89
14.3 PRINTING SETTINGS.....	89
14.3.1 <i>Printing Operations</i>	89
14.4 NOTIFICATION CENTER.....	90
14.5 AUTO UPDATE.....	90
14.6 VEHICLE LIST	90
14.7 BATTERY TEST	91
14.8 SYSTEM SETTINGS	91
14.9 ABOUT.....	91
15 VCI MANAGER	92
15.1 VCI BT PAIRING.....	93
15.2 BAS BT PAIRING	93
15.3 VCI UPDATE	94
15.4 BAS UPDATE.....	95
16 SUPPORT	96
16.1 PRODUCT REGISTRATION	96
16.2 SUPPORT SCREEN LAYOUT	97
16.3 MY ACCOUNT.....	97
16.3.1 <i>Personal Info</i>	97
16.3.2 <i>Update Info</i>	97
16.3.2 <i>Service Info</i>	98
16.4 COMPLAINT	98
16.5 DATA LOGGING	99
16.6 TRAINING	100
16.7 FAQ	100
17 REMOTE DESKTOP	101
18 QUICK LINK	103
19 MAXVIEWER	104
20 MAINTENANCE AND SERVICE	106
20.1 MAINTENANCE INSTRUCTIONS.....	106
20.2 TROUBLESHOOTING CHECKLIST	106
20.3 ABOUT BATTERY USAGE	107
20.4 SERVICE PROCEDURES	108

20.4.1 Technical Support.....	108
20.4.2 Repair Service.....	109
21 COMPLIANCE INFORMATION	110
22 WARRANTY.....	112

1 Using This Manual

This manual contains device usage instructions for the Autel MaxiBAS BT609 Battery Tester.

Some illustrations shown in this manual may contain modules and optional equipment that are not included in your system. Contact your sales representative for availability of other modules and optional tools or accessories.

Conventions

The following conventions are used.

Bold Text

Bold text is used to highlight selectable items such as buttons and menu options.

Example:

- Tap **OK**.

Notes and Important Messages

Notes

A **NOTE** provides helpful information such as additional explanations, tips, and comments.

Example:

 **NOTE**

New Batteries reach full capacity after approximately 3 to 5 charging and discharging cycles.

Important

IMPORTANT indicates a situation which, if not avoided, may result in damage to the test equipment or vehicle.

Example:

 **IMPORTANT**

Keep the cable away from heat, oil, sharp edges and moving parts. Replace damaged cables immediately.

Hyperlink

Hyperlinks, or links, that take you to other related articles, procedures, and illustrations are available in electronic documents. Blue italic text indicates a selectable hyperlink and blue underlined text indicates a website link or an email address link.

Illustrations

Illustrations used in this manual are samples, the actual testing screen may vary for each vehicle being tested. Observe the menu titles and the on-screen instructions to make correct option selection.

Procedures

An arrow icon indicates a procedure.

Example:

➤ **To use the camera:**

1. Tap the **Camera** button. The camera screen opens.
2. Focus the image to be captured in the view finder.
3. Tap the camera icon on the right side of the screen. The view finder now shows and auto-saves the captured photos.
4. Swipe the screen to the left to view the stored image.
5. Tap the **Back** or **Home** button to exit the camera application.

2 General Introduction

The MaxiBAS BT609 wireless battery and diagnostics system uses the adaptive conductance technology to more accurately determine the health of battery than traditional battery testers. The BT609 can quickly display both voltage and health status of the existing battery, register a new battery, and perform advanced battery and electrical diagnostics. The BT609 is also an advanced diagnostics tool that can identify faults in all systems and display live data relating to those faults.

There are three main components to the MaxiBAS BT609:

- MaxiBAS BT609 Tester — handheld wireless battery and diagnostics device
- MaxiBAS B200 Series Tester — battery tester with clamp cable
- MaxiVCI V200 — Vehicle Communication Interface

2.1 MaxiBAS BT609 Tester

2.1.1 Function Description

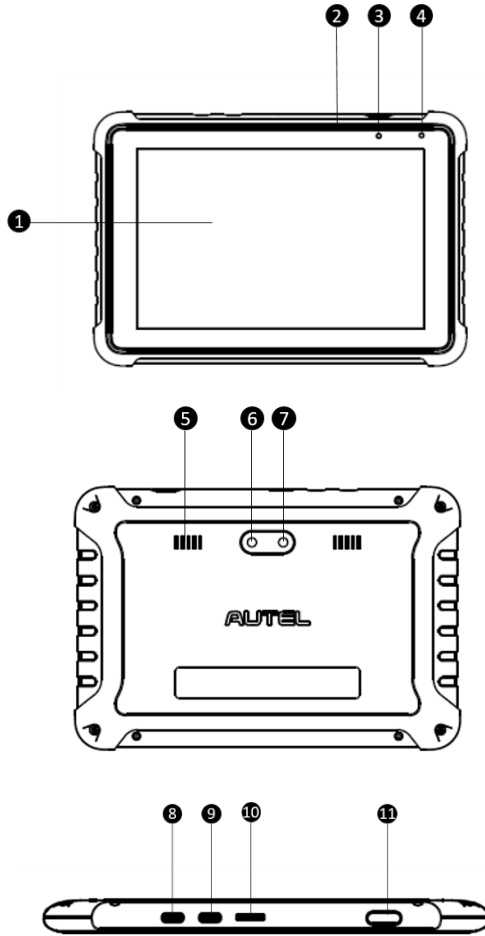

Figure 2-1 MaxiBAS BT609 Front/Back/Side View

1. 7.0-inch Touchscreen
2. Built-in Microphone
3. Power LED
4. Ambient Light Sensor

5. Speaker
6. Camera
7. Camera Flash
8. Type-C USB OTG Port
9. Type-C USB Host Port
10. Micro SD Card Slot
11. Lock/Power Button

Table 2-1 *Power LED Description*

LED	Color	Description
Power	Green	<ul style="list-style-type: none"> ● Lights solid green when the battery is fully charged. ● Flashes green while charging, and the tablet will automatically powers on.
	Red	<ul style="list-style-type: none"> ● Flashes red when illegal operation is detected.

2.1.2 Power Sources

The BT609 tablet can receive power from the following sources:

- Internal Battery Pack
- AC/DC Power Supply

! IMPORTANT

Do not charge the battery when the temperature is below 0°C (32°F) or above 45°C (113°F).

Internal Battery Pack

The BT609 is powered via its internal rechargeable battery, which can provide sufficient power for about 6 hours of continuous operation if fully charged.

AC/DC Power Supply — using power adapter

The tester can be powered via an electrical outlet using the AC/DC power adapter. The AC/DC power supply also charges the internal battery pack.

2.1.3 Technical Specifications

Item	Description
Operating System	Android 9.0
Screen Display	7" LCD touchscreen with 1280 x 800 pixel resolution
Storage	64 GB
Connectivity	<ul style="list-style-type: none">• Wi-Fi (802.11 a/b/g/n/ac)• USB 2.0, Type C (1 USB OTG + 1 USB Host)• Bluetooth 5.0 + EDR
Camera	8 Megapixel
Input Voltage	5 V DC
Internal Battery	3.85 V, 5800 mAh
Working Temperature	0°C to 50°C (32°F to 122°F)
Storage Temperature	-10°C to 60°C (14°F to 140°F)
Dimension (W x H x D)	197 mm (7.75") x 135 mm (5.31") x 14 mm (0.55")
Weight	445g (0.98 lb.)

2.2 MaxiBAS B200 Series Tester

2.2.1 Function Description

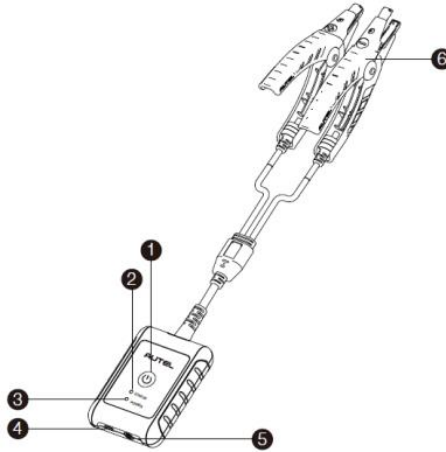

Figure 2-2 MaxiBAS B200 View

1. Power Button
2. Status LED
3. Power LED
4. USB Port
5. Multimeter Cable Port
6. Battery Clamp Cable

Table 2-2 LED Description

LED	Color	Description
Status LED	Flashing Green	The tester is communicating via USB cable.
	Flashing Blue	The tester is communicating via Bluetooth.
	Flashing Red	Battery clamps are connected to the wrong battery terminals.
Power LED	Green	<ul style="list-style-type: none">● Solid Green: The tester is powered on and the battery is sufficiently charged.● Flashing Green: The tester is charging; turns to Solid Green after its battery is fully charged.
	Flashing Red	The battery level is low. Please charge.

2.2.2 Power Sources

The B200 tester can receive power from the following sources:

- Internal Battery Pack
- AC/DC Power Supply

Internal Battery Pack

The B200 can be powered with the internal rechargeable battery.

AC/DC Power Supply — Using Power Adapter

The tester can be powered from an electrical outlet using the AC/DC power adapter. The AC/DC power supply also charges the internal battery pack.

2.2.3 Technical Specifications

Item	Description
Connectivity	<ul style="list-style-type: none">● USB 2.0, Type C● Bluetooth V3.0 BR/EDR + V4.2 LE Dual-Mode
Input Voltage	5 V DC
Working Current	< 150 mA at 12 V DC
CCA Range	100 A to 3000 A
Voltage Range	1.5 V to 36 V
Working Temperature	-10°C to 50°C (14°F to 122°F) -10°C to 45°C (14°F to 113°F) (In Europe)
Storage Temperature	-20°C to 60°C (-4°F to 140°F)
Dimension (L x W x H)	107 mm (4.21") x 75 mm (2.95") x 26 mm (1.02") (clamp cable not included)
Weight	320 g (0.7 lb.)

2.3 MaxiVCI V200 — Vehicle Communication Interface (VCI)

2.3.1 Function Description

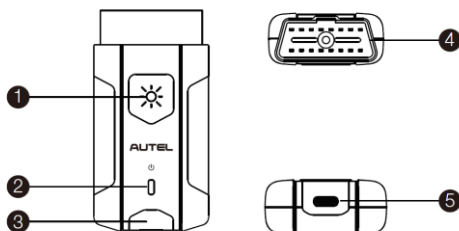

Figure 2-3 *MaxiVCI V200 View*

1. Flashlight Power Button
2. Power LED
3. Vehicle/Connection LED
4. Vehicle Data Connector (16-pin)
5. USB Port

Table 2-3 *VCI LED Description*

LED	Color	Description
Power LED	Yellow	VCI is powered on and performing self-check.
	Green	VCI is ready for use.
	Flashing Red	Firmware is upgrading.
Vehicle / Connection LED	Green	<ul style="list-style-type: none"> ● Solid Green: VCI is connected via USB cable. ● Flashing Green: VCI is communicating via USB cable.
	Blue	<ul style="list-style-type: none"> ● Solid Blue: VCI is connected via Bluetooth. ● Flashing Blue: VCI is communicating via Bluetooth.

2.3.2 Power Sources

The VCI device can receive power from following sources:

- Vehicle Power
- AC/DC Power Supply

Vehicle Power

The VCI device operates on 12/24 Volt vehicle power, which is powered by the vehicle data connection port. The device powers on whenever it is connected to an OBDII/EOBD-compliant Data Link Connector (DLC).





AC/DC Power Supply

The VCI device can be powered from a wall socket using the AC/DC power adapter. The flashlight on the VCI device can be powered by this way.

2.3.3 Technical Specifications

Item	Description
Communications	<ul style="list-style-type: none">● BLE + EDR● USB 2.0
Wireless Frequency	2.4 GHz
Input Voltage Range	6 to 36 V DC
Supply Current	150 mA at 12 V DC
Operating Temperature	-10°C to 50°C (14 ° F to 122 ° F)
Storage Temperature	-40°C to 80°C (-40 ° F to 176 ° F)
Dimensions (L x W x H)	89.89 mm (3.53") x 46.78 mm (1.84") x 21 mm (0.82")
Weight	70.7 g (0.156 lb.)
Built-in Battery	3.7 V Lithium Battery
Light	White LED

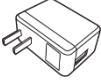
2.4 Other Accessories

	<p>Battery Side Post Terminal Type S (2 pcs) Connects the battery posts and the clamps.</p>
	<p>Battery Side Post Terminal Type T (2 pcs) Connects the battery posts and the clamps.</p>
	<p>Power Adapter Together with the USB cable, connects the unit to an external DC power port for power supply.</p>
	<p>USB Cable Together with the power adapter, connects the unit to an external DC power port for power supply.</p>

3 Getting Started

Ensure the unit is sufficiently charged.

3.1 Power Up

Press and hold the **Lock/Power** button to power up the BT609. The system will boot up and display the Job Menu.

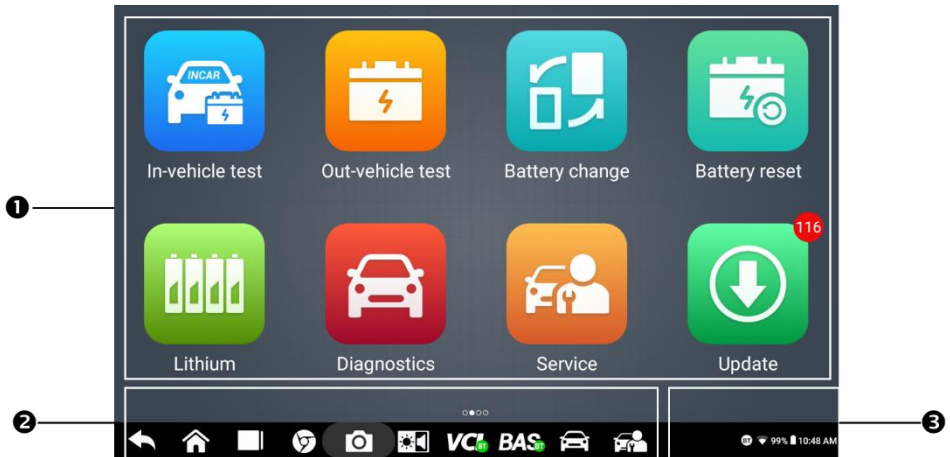

Figure 3-1 Sample BT609 Job Menu

1. Application Buttons
2. Page Indicator and Navigation Buttons
3. Status Icons













NOTE



It is recommended to lock the screen when not in use to protect your information and conserve the power.

3.1.1 Application Buttons

The table below briefly describes each of the applications in the MaxiBAS system.

Table 3-1 *Applications*







Button	Name	Description
	In-vehicle Test	Tests batteries that are installed in a vehicle. See In-vehicle Test on page 19.
	Out-vehicle Test	Tests batteries that are not connected to a vehicle. See Out-vehicle Test on page 27.
	Battery Replace	Operation guide for battery replacement. See Battery Replace on page 29.
	Battery Reset	Accesses the Battery Reset function. See Battery Reset on page 31.
	Lithium	Accesses Lithium battery test and other related functions. See Lithium on page 35.
	Diagnostics	Reads and/or erases trouble codes. See Diagnostics on page 40.
	Service	Accesses the special functions menu. See Service on page 67.
	Multimeter	Accesses the Multimeter function. (The multimeter is sold separately.) See Multimeter on page 72.
	Data Manager	Accesses the saved repair shop, customer, and vehicle data including detailed vehicle diagnostics and test records. See Data Manager on page 79.
	Update	Accesses system software update menu. See Update on page 86.
	Settings	Accesses the VCI Manager, BAS Manager, System Settings Menu, and more. See Settings on page 88.
	VCI Manager	Accesses VCI connection menu. See VCI Manager on page 92.
	Support	Synchronizes Autel's online service database with the diagnostic tablet. See Support on page 96.





Button	Name	Description
	Remote Desktop	Remotely controls the device from any computer or even from another mobile device. Transfers files from the device to a computer, or vice versa. See Remote Desktop on page 101.
	Quick Link	Provides associated website bookmarks to allow quick access to product update, service, support, and other information. See Quick Link on page 103.
	MaxiViewer	Provides a quick search for supported functions and/or vehicles. See MaxiViewer on page 104.

3.1.2 Page Indicator and Navigation Buttons

Operations of the navigation buttons at the bottom of the screen are described in the table below.

Table 3-2 *Page Indicator and Navigation Buttons*

Icon	Name	Description
	Page Indicator	Indicates the position of the current page in a list of pages. The user swipes the screen left or right to view the previous or next page.
	Back	Returns to the previous screen.
	Android Home	Returns to Android System's Home screen.
	Recent Apps	Displays a list of applications that are currently running. Tap an app icon to launch. Remove an app by swiping it to the right.
	Browser	Launches the Chrome Internet browser.
	Camera	Tap to open camera view finder. Press and hold the icon to capture a screenshot of the display screen. The saved files will be automatically in the Data Manager application for later review. See Data Manager on page 79.
	Display & Sound	Adjusts the brightness of the screen and the volume of the audio output.

Icon	Name	Description
	VCI Connection	Opens the VCI Manager application. A green icon at the bottom-right corner indicates the VCI device is connected via Bluetooth, while a red “x” icon will display if connection fails.
	BAS Connection	Opens the VCI Manager application. A green icon at the bottom-right corner indicates the B200 tester is connected via Bluetooth, while a red “x” icon will display if connection fails.
	MaxiBAS Shortcut	Returns to the Diagnostics screen.
	Service	Returns to the Service screen.

➤ **To use the camera:**

1. Tap the **Camera** button. The camera screen opens.
2. Focus the image to be captured in the view finder.
3. Tap the camera icon on the right side of the screen. The view finder now shows and auto-saves the captured photos.
4. Swipe the screen to the left to view the stored image.
5. Tap the **Back** or **Home** button to exit the camera application.

 **NOTE**

After swiping the camera screen from left to right, the camera mode and video mode can be switched by tapping the blue camera icon or video icon.

Refer to your Android documentation for additional information.

3.1.3 System Status Icons

Your MaxiBAS tablet is a fully functional Android tablet with the standard Android operation system status icons. Refer to your Android documentation for more information.

3.2 Power Off

All vehicle communications should be terminated before shutting down the tablet. A warning message displays if a shutdown is attempted while the tablet is communicating with the vehicle. Forcing a shutdown while the tablet is communicating with the vehicle may lead to ECU problems on some vehicles. Please exit the Diagnostics application before shutting down the tablet.

- **To power off the tablet:**
 1. Press and hold the **Lock/Power** button.
 2. Tap **Power off** option.
 3. Tap **OK**.

Reboot System

In case of system crash, press and hold the **Lock/Power** button and tap **Restart** to reboot the system.

3.3 Test Preparation

3.3.1 Inspecting the Battery

Before starting a test, observe the battery for:

- Cracking, buckling or leaking (If you see any of these defects, replace the battery.)
- Corroded, loose or damaged cables and connections (Repair or replace as needed.)
- Corrosion on the battery terminals, and dirt or acid on the case top (Clean the case and terminals using a wire brush and a mixture of water and baking soda.)

3.3.2 Connecting to a Battery

1. Follow the on-screen instructions to pair the B200 series tester with the BT609 via Bluetooth. See pairing instructions in [section 15.2](#).

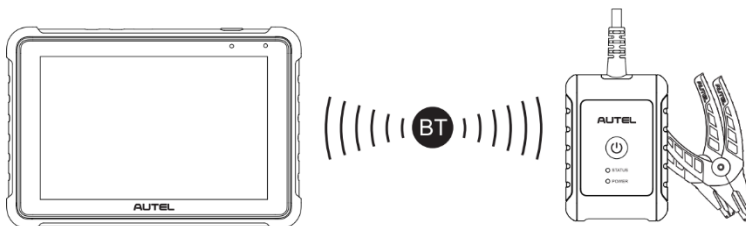

2. Connect the red clamp to the positive (+) terminal and the black clamp to the negative (-) terminal of the battery.

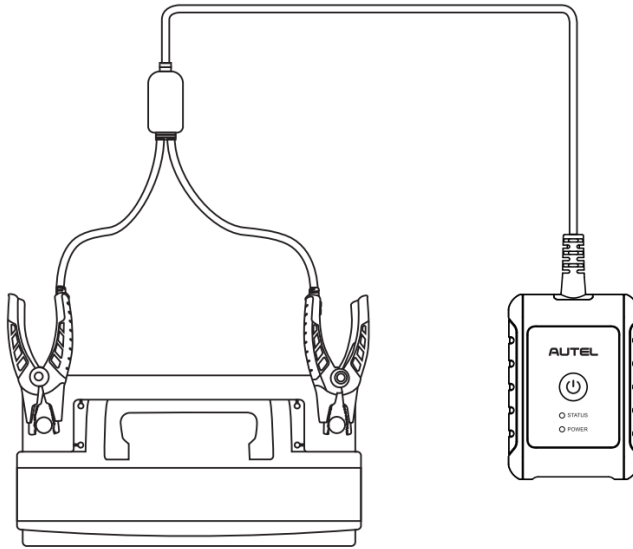

3.4 Establish Vehicle Communication

The Diagnostics operations require pairing the MaxiBAS BT609 tablet with the vehicle through the VCI device (V200) via Bluetooth. To establish proper vehicle communication to the tablet, perform the following steps:

1. Connect the VCI device to the vehicle's DLC for both communication and power source.
2. Pair the VCI device with the tablet via Bluetooth.
3. When the above steps are completed, check the VCI navigation button at the bottom bar on the screen. A green BT icon at the lower-right corner indicates that the MaxiBAS BT609 is now ready to start vehicle diagnosis.

3.4.1 VCI Connection

- **To pair the tablet with the VCI device via Bluetooth:**
 1. Power up the tablet.
 2. Select the **VCI Manager** application from the MaxiBAS Job Menu.
 3. When the VCI Manager application is launched, the tablet automatically scans for available VCI device for Bluetooth pairing. Available devices are listed on the right side of the screen.

 **NOTE**

If no VCI device is found, this may indicate that the signal strength is too weak to be detected. Reposition the VCI device and remove all possible objects that may cause signal interference.

4. The device name will display as "Maxi" suffixed with a serial number.
5. Check the serial number on your VCI label and select the desired device for pairing.
6. When paired successfully, the connection status reads "**Connected**" and the vehicle/connection LED lights solid blue.

4 In-vehicle Test

The In-vehicle Test is used for testing batteries that are installed in a vehicle. An in-vehicle test covers battery, starter, and generator tests. These tests help determine the health status of the battery, starter, and generator.

IMPORTANT



The Disclaimer page will appear when accessing any function on the Home screen for the first time. Please read the end user agreement and TAP **Accept** to continue. If you tap **Decline**, you will not be able to use the features properly.







Prior to testing the battery (batteries), ensure that the B200 series tester is paired with the tablet via Bluetooth.

- To pair the B200 series tester with the tablet:
 1. Power up the tablet.
 2. Select the **BAS Manager** application from the MaxiBAS Job Menu.
 3. When the VCI Manager application is launched, the tablet automatically scans for available tester for Bluetooth pairing.
 4. The device name will display as “Maxi” suffixed with a serial number.
 5. Check the serial number on your B200 series tester label and select the desired device for pairing.
 6. When paired successfully, the connection status will read “**Connected**”.

Please refer to the table below for a list of buttons that may display when accessing the functions.

Table 4-1 *Buttons*

Name	Button	Description
AutoVIN		After the VCI is connected to the device through the vehicle's OBD Data Link Connector (DLC), turn on the ignition. The vehicle's VIN will automatically be recognized.
Battery Connection		The number on the icon indicates the real-time voltage of the test battery. In the battery test, the button will turn green if the battery is good; otherwise, it will turn red.

Name	Button	Description
Scan License		Tap to scan license plate.
Scan VIN		Tap to scan Vehicle Identification Number (VIN).
Battery Location		Tap to check the battery location diagram.
Next		Tap to proceed.
Home		Returns to the MaxiBAS Job Menu.
Back		Returns to the previous screen.
Exit		Returns to the Job Menu.

4.1 Start the Test

Select **In-vehicle Test** on the Job Menu and choose your desired vehicle type from Automobile, Truck Group31, Commercial 4D/8D, Motorcycle, Lawn Mower or Marine to start the test. These choices will be available only after the **Application scenarios** is enabled in **Settings**. The OBD connector location will display when entering the In-vehicle Test.

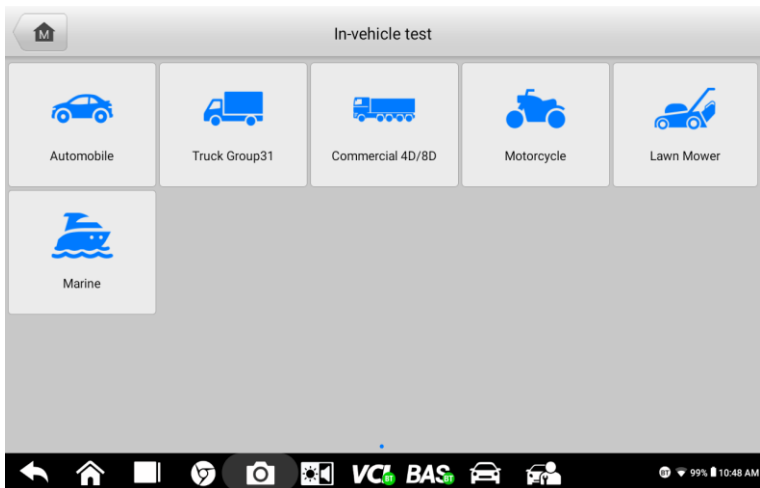

Figure 4-1 Sample In-vehicle Test Home Screen

Confirm Vehicle Information

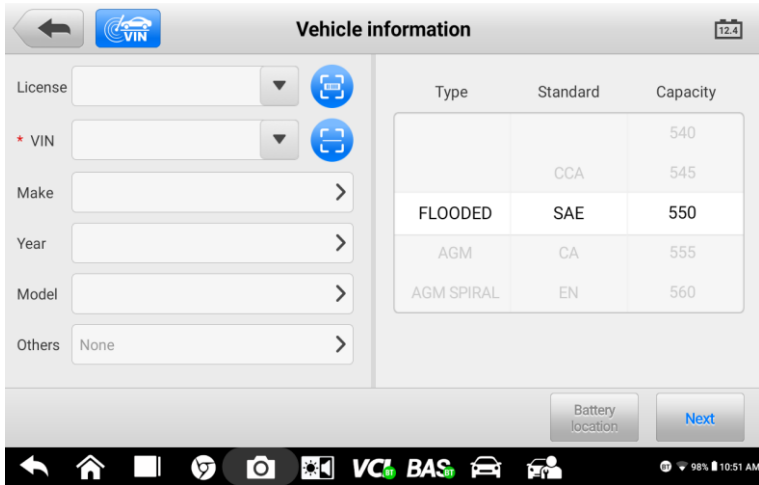

Figure 4-2 Sample Vehicle Information Screen

NOTE

The Scan License feature is supported in limited countries and regions. Manually enter the license number if it is not available.

1. The vehicle information will be automatically identified when vehicle communication is established.
2. Tap **Battery Location** on the bottom-left corner of the screen and review the battery location diagram.
3. Locate the battery, check the battery information on it, and select the correct battery parameters on the right side of the screen.
4. Confirm the information on the Vehicle information screen. Tap the corresponding field to manually input the correct parameters if needed. Tap **Next** to continue.

Before entering the battery test, a Visual inspection screen will display if it is enabled in **Settings**. Enter or scan the battery barcode which can be viewed on the battery. Then, observe the battery for any physical damage, poor installation and/or battery leakage. If any of these damage is observed, tap on the corresponding box(s) under the “Battery appearance inspection”. The user can also add more details of the battery into the input field, as well as photos.

It is not required to fill in the “Visual inspection” information which will display in the battery reports. The user can decide whether to complete this part depending on the actual case.

NOTE

If the Visual inspection is not enabled in **Settings**, the user will be directed to the “Battery Test” main screen after completing the vehicle information.

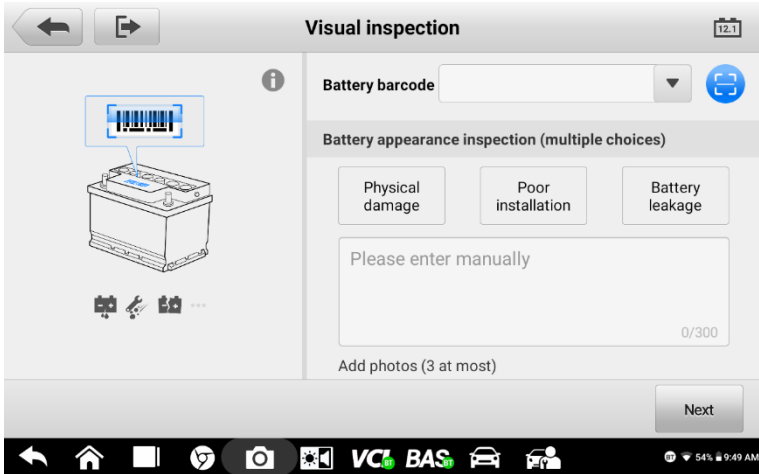

Figure 4-3 Sample Visual Inspection Screen 1

4.2 Battery Test

1. Follow the on-screen instructions, check the boxes once listed tasks are completed, and tap **Start Testing**.

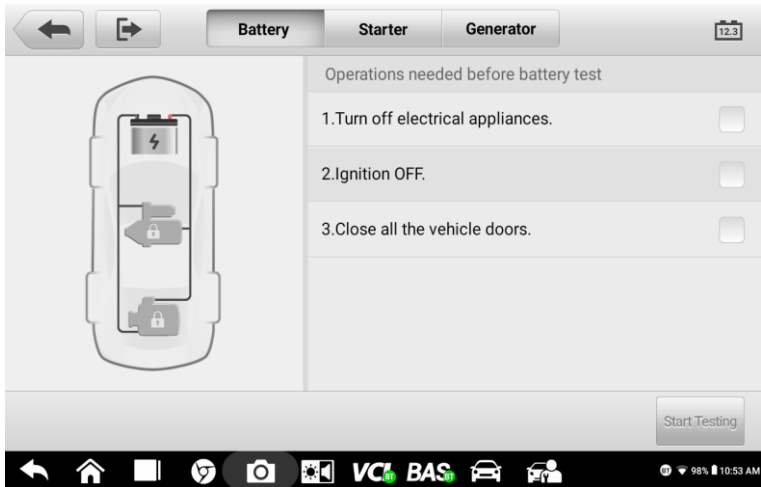

Figure 4-4 Sample Battery Screen

2. Wait until the test is completed. The test results will be displayed on the tablet.

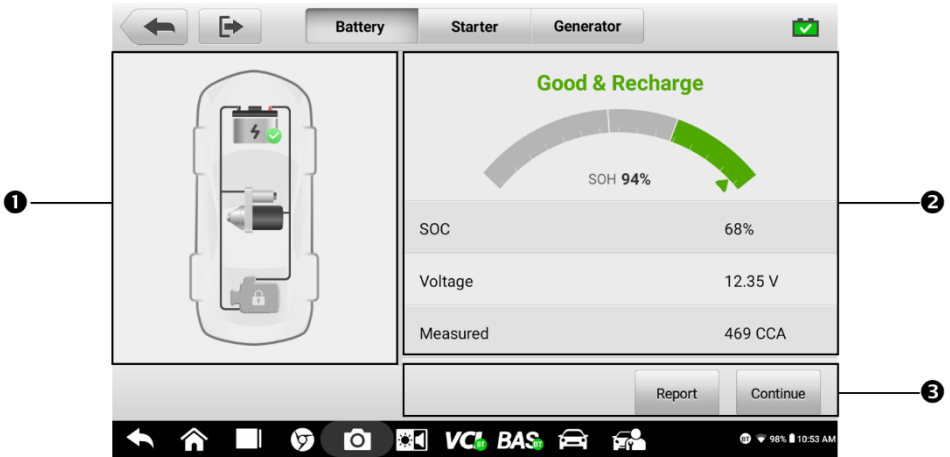

Figure 4-5 Sample Battery Test Result Screen

- 1) Process Buttons
- 2) Test Report
- 3) Function Buttons

Process Buttons

Tap any of the process buttons to advance to the corresponding test — battery test, starter test or generator test. A status icon will display on the lower-right corner of the button, indicating the test results.

Battery Test Results

The battery test results include a color-coded result summary, a list of test data, and repair tips.

Table 4-2 Test Results

Result	Repair Tip
Good Battery	Battery is good.
Good & Recharge	Battery is good but insufficiently charged. Recharge the battery.
Charge & Retest	Battery requires charge to determine its condition.
Bad Cell	Replace the battery.
Replace Battery	Replace the battery.

Function Buttons

The function buttons at the bottom of the screen vary depending on the operation. Functions include Report and Replace Battery. The table below provides a brief description of the function buttons operations.

Name	Description
Report	Tap to view the test data and results in report form. Tap Print on the bottom of the screen to print the test report. Tap Email to send the test report to an email address.
Replace Battery	Tap to continue to replace the battery. See Battery Replace on Page 29.
Continue	Tap to perform the next test.

NOTE

Please always complete the battery test before you proceed to the starter and generator tests.

4.3 Starter Test

Follow the on-screen instructions to complete the test. Start the engine and let it idle. The test results will display as follows.

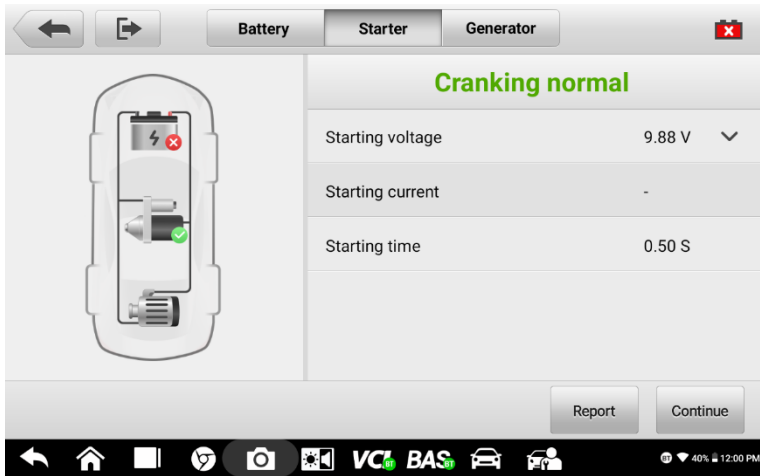

Figure 4-6 Sample Starter Test Result Screen

Table 4-3 Starter Test Results

Result	Description
Cranking Normal	The starter is good.
Current Too Low	Low momentary discharge capacity.
Voltage Too Low	Low battery storage capacity.
Not Started	The starter is not detected for starting.

4.4 Generator Test

Follow the on-screen instructions to complete the test. The test results will be displayed as follows:

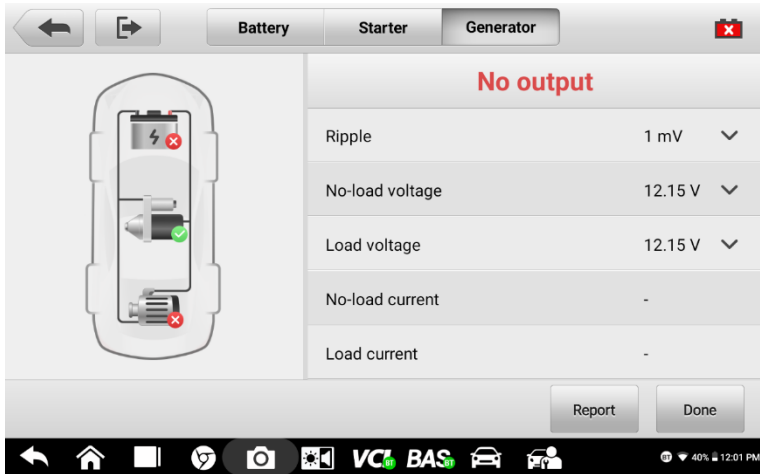

Figure 4-7 Sample Generator Test Result Screen

Table 4-4 Generator Test Results

Result	Description
Charging Normal	The generator is good.
Output Too Low	<ul style="list-style-type: none"> ● The belt linking the starter and the generator is loose. ● The cable linking the starter and the battery is loose or corroded.
Output Too High	<ul style="list-style-type: none"> ● The generator is not properly connected to the ground. ● The voltage adjuster is broken and needs replacement.
Ripple Too Large	The commutation diode is broken.
No Output	<ul style="list-style-type: none"> ● The cable is loose. ● Some vehicles with power management systems do not provide path for charging due to the sufficient load capacity of the battery. ● The generator or the voltage adjuster is broken and needs replacement.

NOTE

To measure the current, connect the current clamp. Tap the **Settings** button on the Home screen to enter the application. Swipe the Current Clamp switch toggle **ON**.

Connecting Current Clamp

Before connecting the current clamp, ensure the multimeter (DM100) is properly connected to the B200 series tester. (See [section 11.2](#) for multimeter connection instructions.)

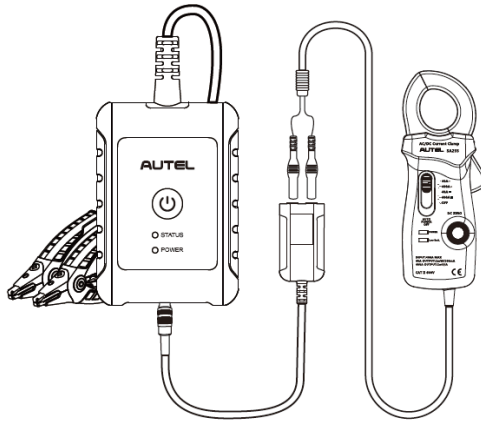

1. Plug the red output cable into the red input of the multimeter and the black output cable into the black input.
2. Connect the multimeter to the B200 series tester and tighten the connector of the multimeter.

5 Out-Vehicle Test

Out-vehicle Test is used to test the condition of batteries that are not connected to a vehicle. This function aims to check the health status of the battery only. The compatible battery types and standards are as follows:

Types: FLOODED, AGM, AGM SPIRAL, EFB, and GEL

Standards: CCA, SAE, CA, EN, EN2, IEC, DIN, JIS, MCA, BCI, and GB

5.1 Test Procedure

1. Connect the battery tester clamps to the battery terminals.
2. Select the appropriate battery type, rating standard, and CCA value. Tap **Next** to continue. The Visual inspection screen will display if visual inspection is enabled in **Settings**; otherwise, the out-vehicle test results will display.

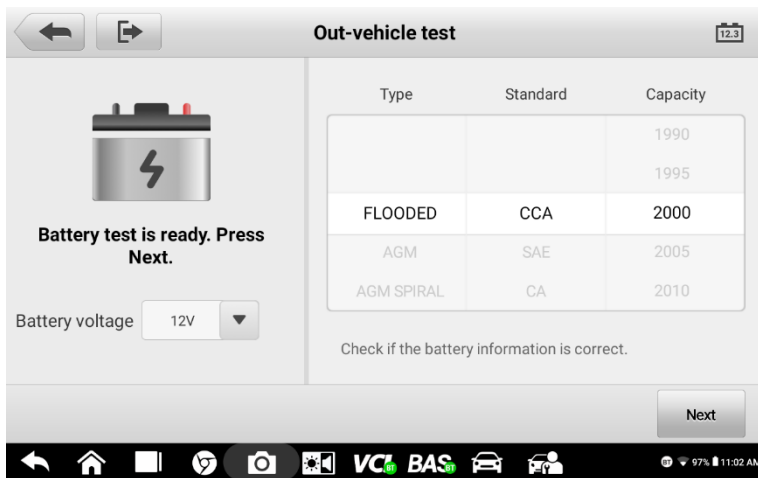

Figure 5-1 Sample Out-vehicle Test Screen

3. The test results will display in a few seconds.

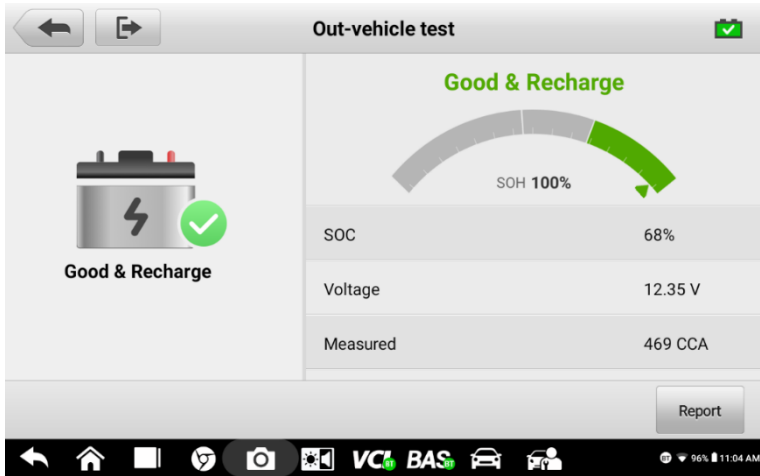

Figure 5-2 Sample Out-vehicle Test Results Screen

5.2 Test Results

Icons are color-coded to indicate status.

Result	Description
Good Battery	Battery meets required standards.
Good & Recharge	Battery is good, but low on charge. Fully charge the battery. Check for causes of low charge.
Charge & Retest	Battery requires charge to determine its condition.
Replace Battery	Battery fails to meet industry-accepted standards.
Bad Cell	Battery fails to meet industry-accepted standards.

6 Battery Replace

The Battery Replace function guides you through replacing the battery step by step. The battery replacement process includes battery type selection, preparation for battery replacement, replacing the battery, new battery selection, new battery test, and battery registration.

➤ **To replace the battery:**

1. Tap **Help** at the bottom of each screen to read all the help information carefully before operation, then follow the on-screen instructions to complete the battery replacement.

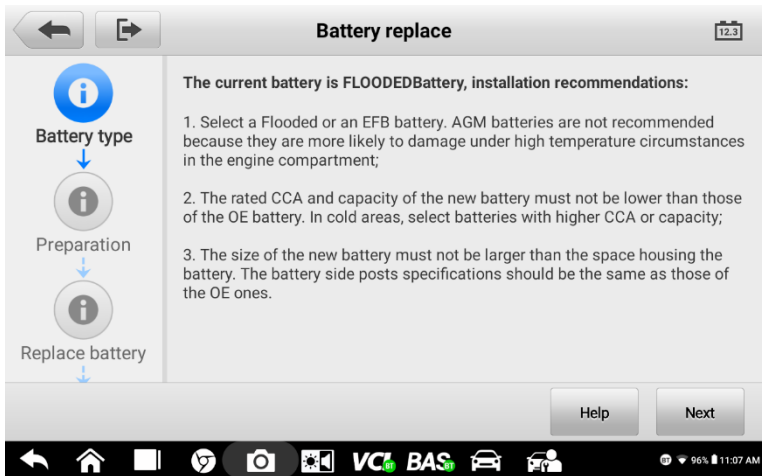

Figure 6-1 *Sample Battery Replace Screen*

2. To save the vehicle's onboard data when the vehicle's battery is removed or disconnected, it is recommended that you use a memory saver (optional accessory) to connect a spare battery to the vehicle.

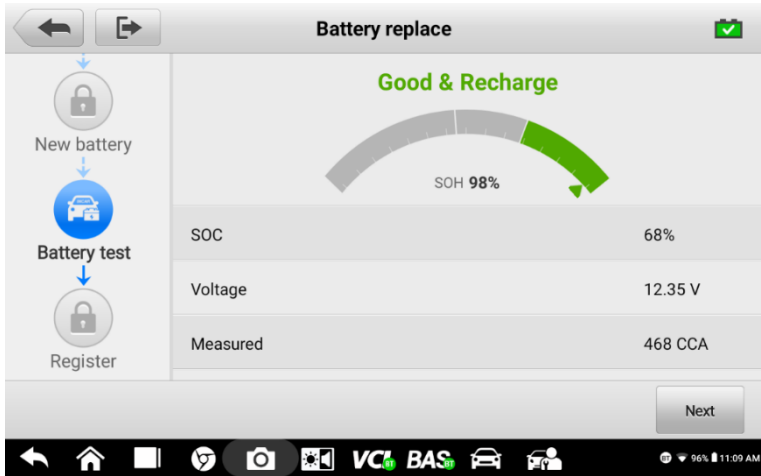

Figure 6-2 Sample New Battery Test Results Screen

3. When the new battery test is completed, tap **Register** to automatically proceed with the Auto Registration in the Battery Reset chapter.

7 Battery Reset

The Battery Reset allows users to access the following functions: Auto registration (after battery replacement), BMS reset, Electric appliance reset, Special function and Battery usage history. This interface differs depending on the specific vehicle.

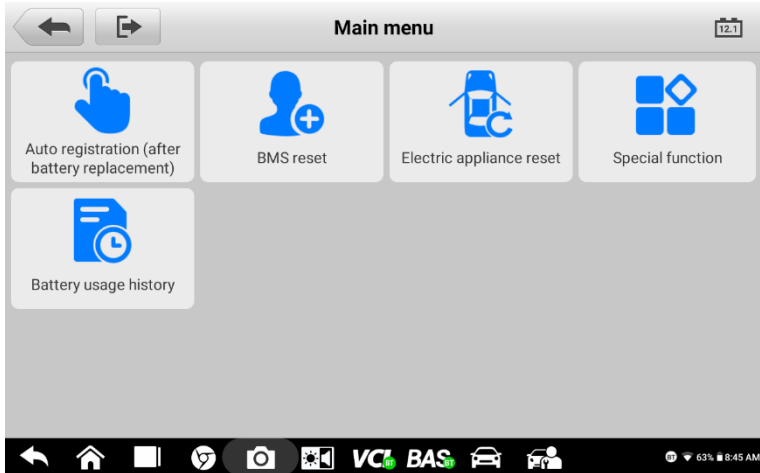

Figure 7-1 Sample Battery Reset Main Menu Screen

7.1 Auto Registration (after battery replacement)

The Auto registration is often used after the successful installation of a new battery. This interface varies depending on the vehicle make. Follow the on-screen instructions to complete the registration process.

NOTE

1. For BMW vehicles or some other vehicles, information including Scene (task), Condition (requirements), Influence (effect), and Note will display after entering the Auto Registration. Other operation procedures might follow when registering new batteries on these vehicles.
 2. The name of the function will turn orange after use.
-

7.2 BMS Reset

The BMS reset feature enables you to register a new battery after a battery replacement. The BMS Reset function varies by vehicle make. Please follow the on-screen instructions to perform the desired functions.

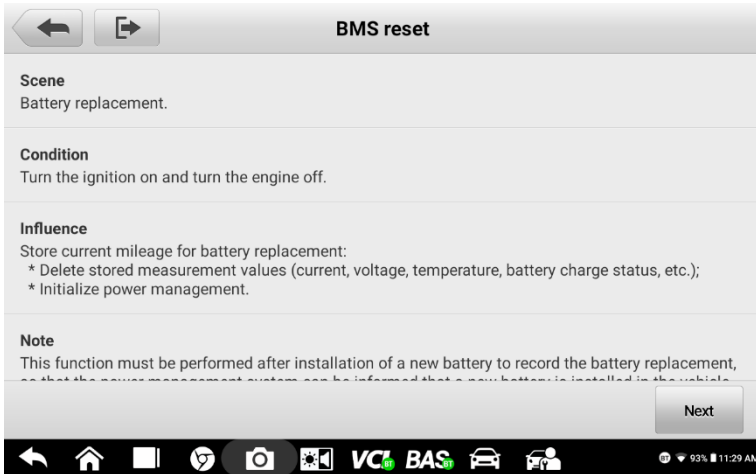

Figure 7-2 Sample BMS Reset Screen

7.3 Electric Appliance Reset

When the vehicle power is interrupted in order to replace the battery, and a memory saver has not been used, position settings on some vehicle components will be lost. These settings should be relearned. The functions and related operations in Electric appliance reset vary by vehicle make. Please follow the on-screen instructions to perform the desired functions.

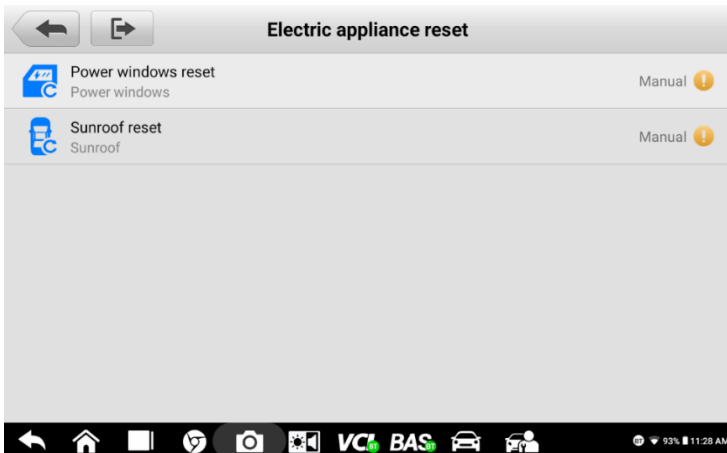

Figure 7-3 Sample Electric Appliance Reset Screen

7.4 Special Function

The special function varies by vehicle make. Functions other than Battery Reset are categorized as special functions. Please follow the on-screen instructions to perform the desired functions.

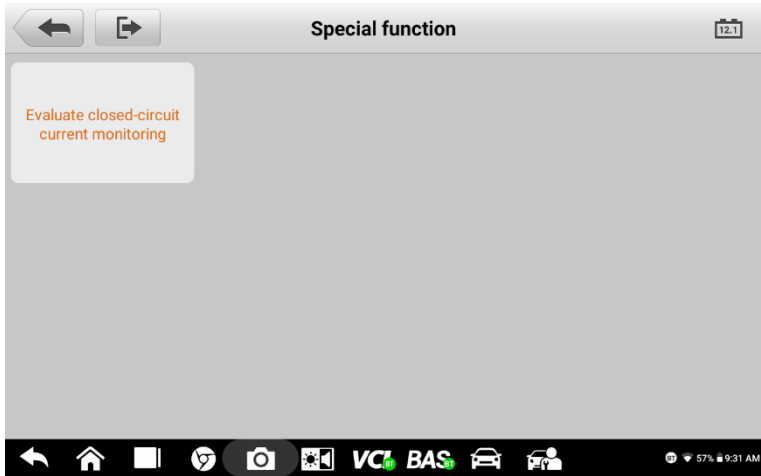

Figure 7-4 Sample Special Function Screen (BMW vehicles)

7.5 Battery Usage History

The Battery Usage History function will display different tests for different vehicles.

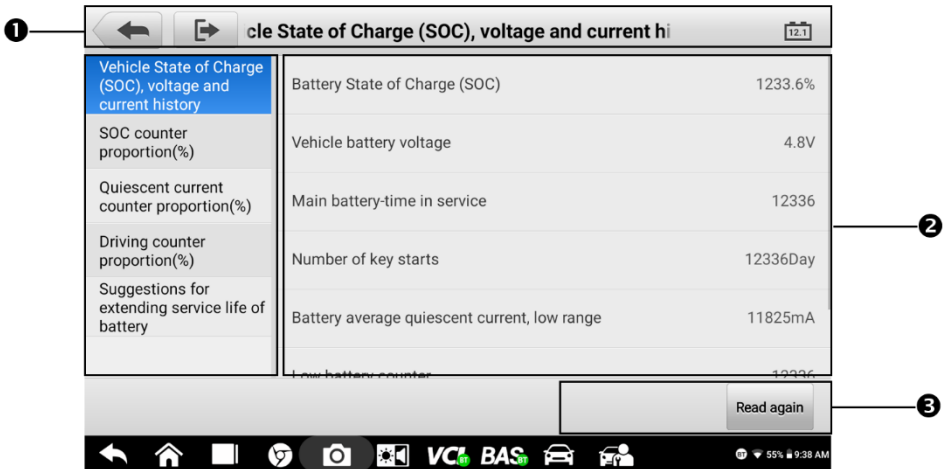

Figure 7-5 Sample Battery Usage History Screen

1. Top Toolbar Buttons
 2. Main Section
 - a) Left column — displays the test menu, from which the user can choose the desired test or other content, such as suggestions for the vehicle battery.
 - b) Right column — displays test results, which can be shown in a bar graph, text, or line chart. Some screens will also display data descriptions for the user, so that they can better understand the test results.
 3. Function Button

In this section, the user can use the **Read again** button for retesting.
-

 **NOTE**

The Battery Usage History function is only available for BMW and Volvo vehicles at present.

8 Lithium

The Lithium function provides access to various functions related to the Lithium-ion battery, including Lithium-ion battery test, ECU information check, special function, electric appliance reset, and BMS reset. The functions of electric appliance reset and BMS reset are similar to those of the BMS Reset function in [Chapter 7](#). The user can refer to that chapter for more information. The interface may differ depending on the specific vehicle.

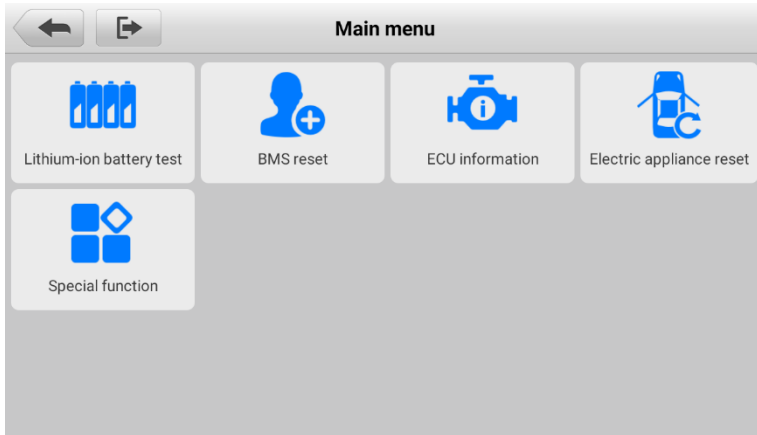

Figure 8-1 Sample Lithium Main Menu

8.1 Lithium-ion Battery Test

To enter the Lithium-ion battery test, input correct vehicle information and choose a Lithium battery voltage (either 48 V or 12 V, depending on the specific vehicle).

Table 8-1 Upper Toolbar and Function Buttons

Button	Description
Visual inspection	Tap to access the visual inspection.
Trouble codes	Tap to view the trouble codes.
Live data	Tap to view the live data.
Erase codes	Tap to erase the trouble codes.
Next	Tap to proceed.
Report	Displays the live data in report form.

8.1.1 Visual Inspection

After entering the battery test, first check the battery for any damage. If any problem depicted on the screen is observed on the battery, swipe the toggle(s) to the right. Tap **Next** to continue.

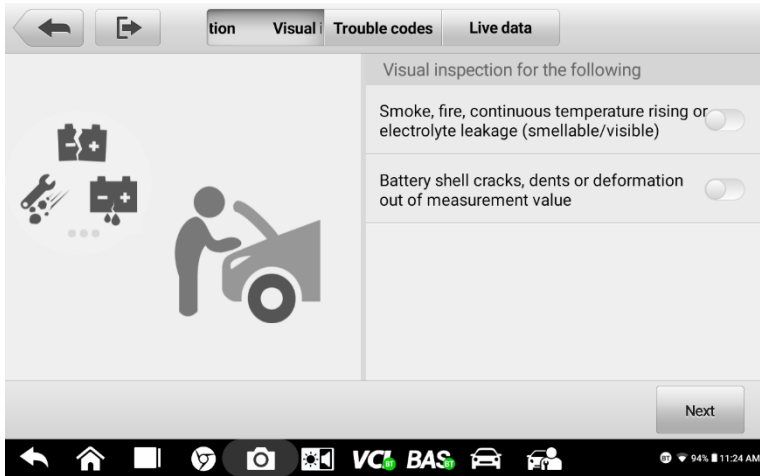

Figure 8-2 Sample Visual Inspection Screen

8.1.2 Trouble Codes

This function retrieves and displays the DTCs from the vehicle's control system. The Trouble codes screen varies by each vehicle model being tested.

After reading the retrieved codes from the vehicle and completing repairs, tap the **Erase codes** button to erase the codes from the vehicle. Before performing this function, make sure the vehicle's ignition key is in the **ON (RUN)** position with the engine off.

After the codes are erased, tap **Next** to proceed with the Live data function.

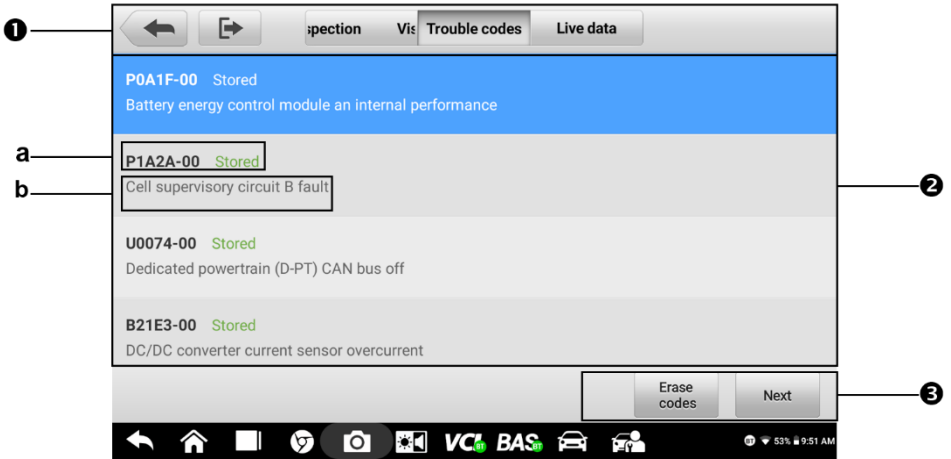

Figure 8-3 Sample Trouble Codes Screen

1. Upper Toolbar
2. Main Section
 - a) Indicates the code name and the status.
 - b) A description of the code.
3. Function Buttons

8.1.3 Live Data

The Live data function will display the data list for the selected module. The parameters will display in the order that they are transmitted by the ECU, and the screen varies depending on the vehicle make.

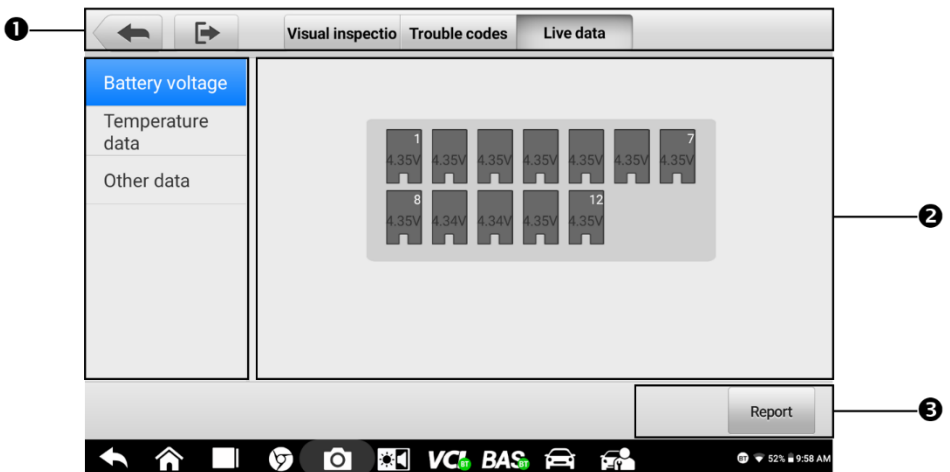

Figure 8-4 Sample Live Data Screen

1. Upper Toolbar
2. Main Section
 - a) Right column — displays the parameter names.
 - b) Left column — displays the values of the parameters. When a value exceeds the set limits, it will display red.
3. Function Button

Display Mode

There are four types of display modes available for data viewing, which allow you to view various types of parameters in the most suitable way.

Tap the wrench-shaped icon on the right side of the screen to open a submenu. A total of six buttons will be displayed: The four buttons on the left represent different data display modes, and one **Unit Change** button (for switching the unit of the displayed data), and one **Trigger** button (tap to open the “trigger setting” window). For more information on the display modes, go to the [Live Data](#) function in the next chapter.

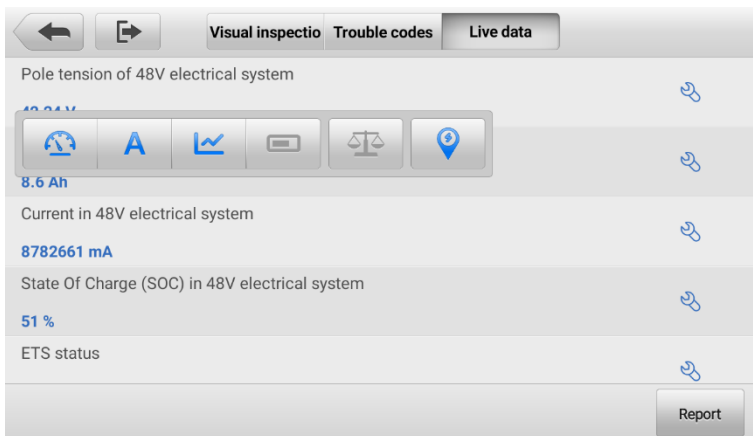

Figure 8-5 Sample Display Mode Screen

- **Analog Gauge Mode** — displays the parameters in gauge charts.
- **Text Mode** — the default mode that displays the parameters as a text list.
- **Waveform Graph Mode** — displays the parameters in waveform graphs.
- **Digital Gauge Mode** — displays the parameters in the form of a digital gauge graph.

Trigger Setting

On the trigger setting screen, you can set a standard range by filling in a Minimum value and a Maximum value. When exceeding this range, the trigger function will be executed and the device will automatically record and save the generated data. You can check the saved live data by tapping the **Review** button at the bottom of the screen.

8.2 ECU Information

This function retrieves and displays the specific information for the tested control unit, including production type and serial number.

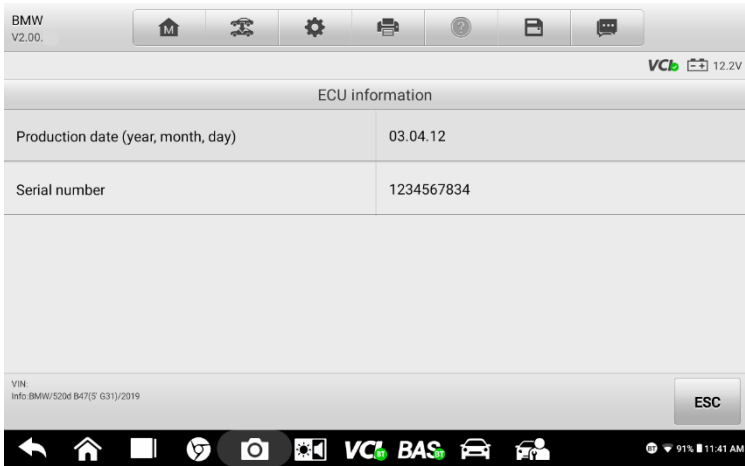

Figure 8-6 Sample ECU Information Screen

8.3 Special Function

The special function in this section specifically tests the vehicles installed with lithium batteries, different from that of the BMS Reset chapter. The special function screen varies by vehicle make. Please follow the on-screen instructions to perform the desired functions.

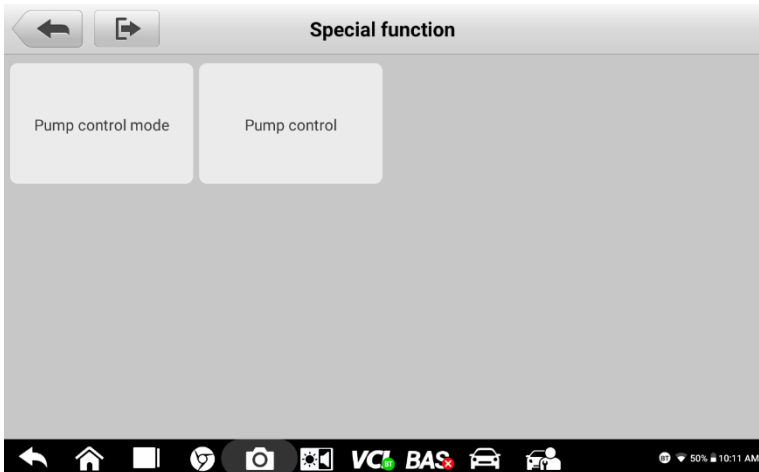

Figure 8-7 Sample Special Function Screen

9 Diagnostics

NOTE

Prior to the use of the Diagnostics function, ensure the VCI (V200) is properly connected to and is communicating with the tablet.

The Diagnostics application can access the electronic control module of multiple vehicle control systems, including but not limited to the engine, transmission, antilock brake system (ABS), and airbag system (SRS).

9.1 Getting Started

9.1.1 Vehicle Menu Layout

When the VCI is properly connected to the vehicle and paired to the tablet, the platform is ready to start vehicle diagnosis. Tap on the **Diagnostics** button on the MaxiBAS Job Menu, and the Vehicle Menu will display on the screen.

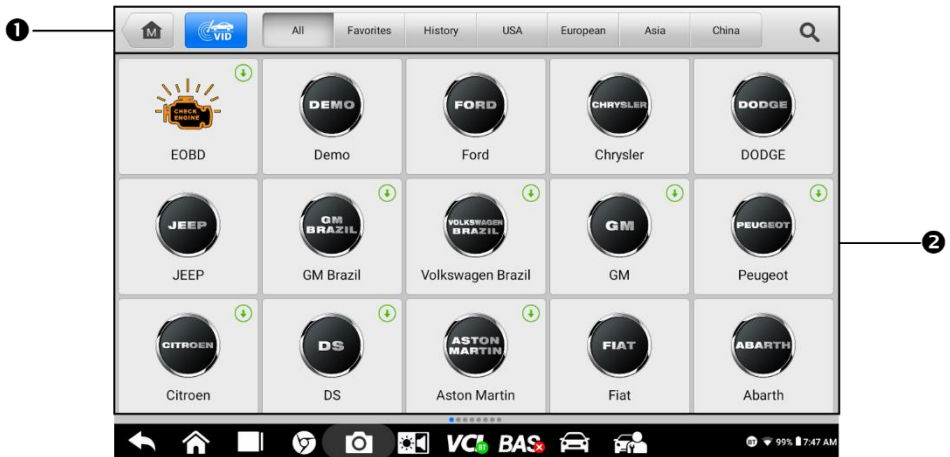













Figure 9-1 Sample Vehicle Menu Screen

1. Top Toolbar Buttons
2. Manufacturer Buttons

Top Toolbar Buttons

The operations of the toolbar buttons at the top of the screen are listed and described in the table below:

Table 9-1 *Top Toolbar Buttons*

Name	Button	Description
Home		Returns to the MaxiBAS Job Menu.
VID Scan		Tap to open a drop-down list: tap Auto detect for auto VIN detection; tap Manual input to enter VIN code/license number manually. Tap Scan VIN/License to scan the barcode/VIN code/license plate number by camera.
All		Displays all the vehicle makes in the vehicle menu.
Favorites		Displays user-favorite vehicle makes.
History		Displays stored vehicle test records. See Vehicle History .
USA		Displays vehicles from U.S. automakers.
European		Displays vehicles from European automakers.
Asia		Displays vehicles from Asian automakers.
China		Displays vehicles from Chinese automakers.
Search		Tap the search field to show the virtual keyboard and enter a vehicle manufacturer name.
Cancel		Tap this button to exit the search screen or to cancel an operation.

Vehicle Manufacturer Buttons

The Manufacturer buttons lists available vehicle brands for testing. Select the manufacturer button after the VCI is properly connected to the test vehicle to start a diagnostics session.

9.2 Vehicle Identification

The MaxiBAS diagnostics system supports five methods of Vehicle Identification.

1. Auto VIN Scan
2. Manual Input
3. Scan VIN/License
4. Manual Vehicle Selection
5. OBDII Direct Entry

9.2.1 Auto VIN Scan

The MaxiBAS diagnostics system features the latest VIN-based Auto VIN Scan function to identify vehicles with just one tap, enabling you to quickly identify the exact vehicle and scan its available systems for fault codes.

➤ **To perform Auto VIN Scan:**

1. Tap the **Diagnostics** button from the Job Menu. The Vehicle Menu should display.
2. Tap the **VID Scan** button on the top toolbar.
3. Select **Auto detect**. The tablet starts VIN scanning on the vehicle's ECU. Once the test vehicle is successfully identified, the system will guide you to the Vehicle Diagnostics screen.

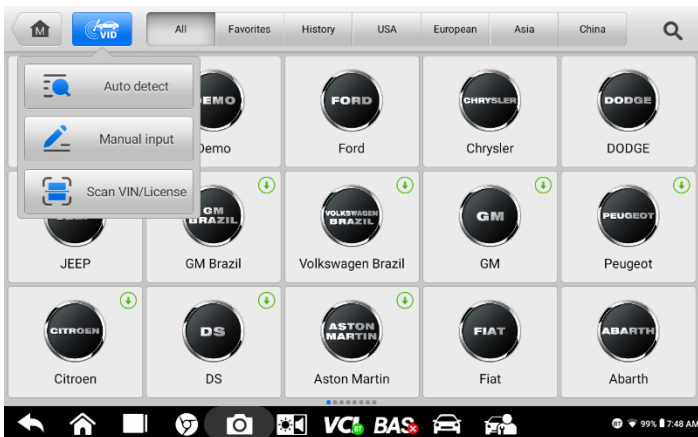

Figure 9-2 Sample Auto Detect Screen

Depending on the vehicle, the Auto VIN function may be still available after a vehicle brand is selected. Select **Automatic selection** and the system will acquire VIN information automatically or allow users to enter the VIN manually.

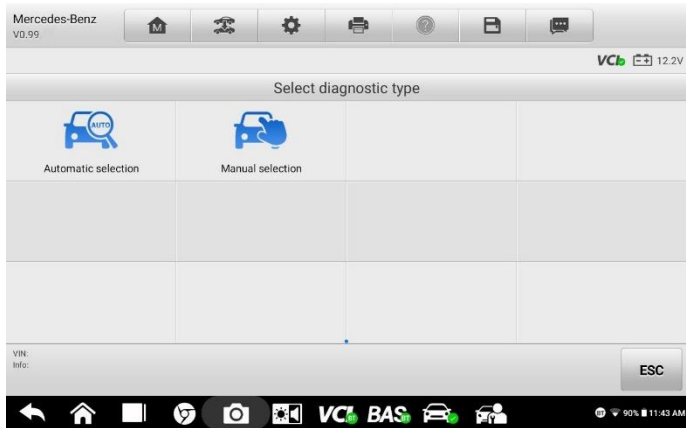

Figure 9-3 Sample Vehicle Selection Screen

9.2.2 Manual Input

For vehicles that do not support the Auto VIN Scan function, the MaxiBAS diagnostics system allows you to enter the vehicle VIN or license number manually, or simply take a photo of the VIN sticker for quick vehicle identification.

➤ To perform Manual Input

1. Tap the **Diagnostics** button from the MaxiBAS Job Menu. The Vehicle Menu displays.
2. Tap the **VID Scan** button on the top toolbar.
3. Select **Manual input**.
4. Tap the input box and enter the correct VIN code or license number.
5. Tap **OK**. The vehicle will be identified and matched to the vehicle database and the Vehicle Diagnostics screen will display.
6. Tap the “x” icon on the top-right corner to exit Manual input.

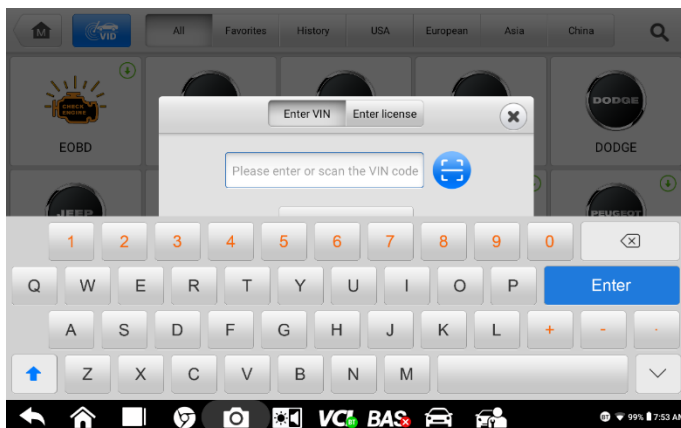

Figure 9-4 Sample Enter VIN Screen

9.2.3 Scan VIN

Tap **Scan VIN** in the drop-down list (see Figure 9-2), and the camera will open. On the right side of the screen, from top to bottom, three options are available: **Scan Bar Code**, **Scan VIN**, and **Scan License**.

Note

The license plate recognition method is supported in limited countries and regions. Please manually enter the license number if it is not available.

Select one of the three options and position the tablet to align the VIN or license number within the scanning window, the result will display in the Recognition Result dialog box after scanning. Tap **OK** to confirm the result, and then the vehicle information confirmation screen will display. If all the vehicle information is correct, tap the icon in the middle of the screen to confirm the VIN of the test vehicle. Tap **OK** to continue.

If the VIN/License number can't be scanned, please manually enter the VIN/License number after tapping the pen (✎) icon. Tap **OK** to continue. Manually enter the license number and select a vehicle brand in the vehicle information confirmation screen. Tap the **Diagnostics** icon in the middle of the screen to confirm the VIN of the test vehicle. Tap **OK** to continue.

9.2.4 Manual Vehicle Selection

When the VIN is not automatically retrievable through the vehicle's ECU or the specific VIN is unknown, you can select the vehicle manually.

Step-by-step Vehicle Selection

This mode of vehicle selection is menu driven. Tap the **Manufacturer** icon on the Vehicle Menu screen and the Select diagnostic type screen displays. Tap **Manual Selection**. Select the vehicle information (e.g., brand, model, capacity, engine type, and model year). Each selection advances you to the next screen. The **ESC** button will bring you back to the previous screen.

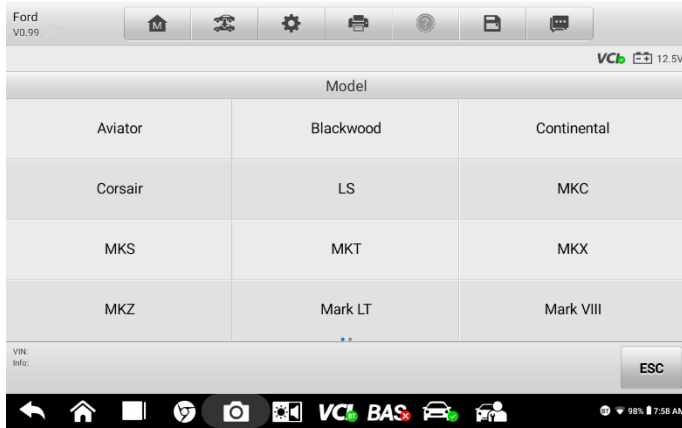

Figure 9-5 Sample Manual Vehicle Selection Screen

9.2.5 Alternative Vehicle Identification

Occasionally, the tablet may not be able to identify a vehicle. For these vehicles, the user may perform a generic OBDII or EOBD diagnostic test. See [Generic OBDII Operations](#) for additional information.

9.3 Diagnostics Screen Layout

After the vehicle information is selected, tap the **Yes** button at the bottom-right corner of the screen to open the Diagnostic menu page. This section consists of commonly used functions, including Auto Scan, Control Unit, and more. The available functions vary by vehicle.

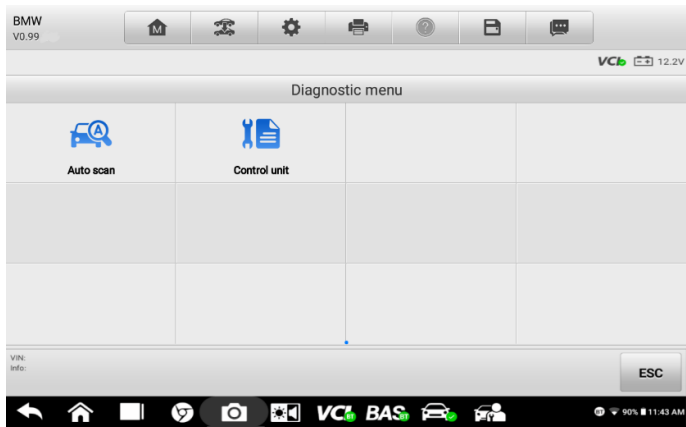

Figure 9-6 Sample Diagnostics Menu Screen

9.4 Auto Scan

The Auto Scan function performs a comprehensive scan on all the systems in the vehicle ECU to locate faults and retrieve DTCs.

➤ To perform an Auto Scan:

1. Tap the **Diagnostics** button on the MaxiBAS Job Menu. Choose the corresponding vehicle information and enter the vehicle diagnostics page.
2. Select **Auto Scan** on the main menu to enter the diagnostics interface.
3. The vehicle system modules will be automatically scanned.

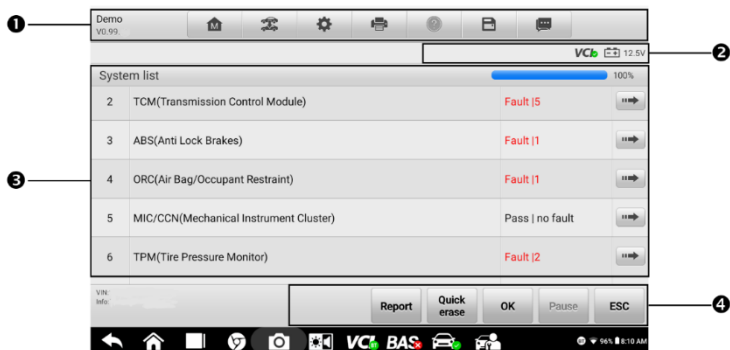

Figure 9-7 Sample Auto Scan Operation Screen

1. Diagnostics Toolbar
2. Status Information Bar







3. Main Section

4. Function Buttons

Diagnostics Toolbar

The Diagnostics Toolbar contains buttons that allow you to print or save the displayed data and perform other operations. The table below provides a brief description of the operations of the Diagnostics toolbar buttons:

Table 9-2 *Diagnostics Toolbar Buttons*

Name	Button	Description
Home		Returns to the MaxiBAS Job Menu.
Vehicle Swap		Exits the diagnostic session and returns to the vehicle menu screen to select another vehicle for testing.
Settings		Opens the Settings screen. See Settings on page 88.
Print		Saves and prints a copy of the displayed data. See Printing Settings on page 89.
Help		Provides instructions and tips for operations of various diagnostic functions.
Save		Provides two ways to save data: <ul style="list-style-type: none">● Tap Save This Page to take a screenshot image.● Tap Save All Data to save a PDF file (this option is used when data displays on multiple screens). These files are stored in the Data Manager application for later review. See Data Manager on page 79.
Data Logging		Use this function when encountering an error while testing or diagnosing a vehicle. This function will record communication data and ECU information from the test vehicle and send it to Autel technical staff to review and provide a solution. Go to the Support application to follow up the case. See Data Logging on page 99.

➤ **To print the Diagnostics data:**

1. Tap the **Diagnostics** button on the Job Menu. The **Print** button on the diagnostics toolbar is available throughout the Diagnostics operations.
2. Tap **Print** and a drop-down menu will display.
 - a) **Print This Page** — prints a copy of the current screen only.
 - b) **Print All Data** — prints a PDF copy of all displayed data.
3. A temporary file will be created and sent via the computer to the printer.
4. When the file is sent, a confirmation message will display.

 **NOTE**

Make sure the tablet and the printer are connected properly before printing.

➤ **To submit Data Logging reports in Diagnostics:**

1. Tap the **Diagnostics** button from the MaxiBAS Job Menu. The **Data Logging** button on the diagnostics toolbar is available throughout the Diagnostics operations.
2. Tap the **Data Logging** button to display the error options. Select a specific error and a submission form will display to let you fill in the report information.
3. Tap the **Send** button in the upper-right corner of the screen to submit the report via the Internet, and a confirmation message will display when sent successfully.

Status Information Bar

The Status Information Bar at the top of the Main Section displays the following items:

- **VCI Icon** — indicates the communication status between the tablet and the VCI device.
- **Battery Icon** — indicates the battery status of the vehicle.

Main Section

The Main Section varies depending on the stage of operations which shows vehicle identification selections, the main menu, test data, messages, instructions, and other diagnostic information.

Column 1 — displays the system numbers.

Column 2 — displays the scanned systems.

Column 3 — displays the scan results.

- **-!-**: Indicates that the scanned system may not support the code-reading function, or that there is a communication error between the tester and the control system.
- **-?-**: Indicates that the vehicle control system has been detected, but the tester cannot access it.
- **Fault | #**: Indicates there is/are detected fault code(s) present; “#” indicates the quantity of detected faults.

- **Pass | No Fault:** Indicates the system was scanned and no faults were detected.
- **Not Scanned:** Indicates the system has not been scanned.
- **No Response:** Indicates the system has not received a response.

Column 4 — to perform further diagnosis or testing on a specific system item, tap the arrow button to the right of that item. A Function Menu screen will display.

Function Buttons

The table below provides a brief description of the Function Buttons' operations:

Table 9-3 *Function Buttons on the Diagnostics Screen*

Name	Description
Report	Displays the diagnostic data in report form.
Quick erase	Deletes codes. A warning message screen will display to inform you of possible data loss when this function is selected.
OK	Confirms the test results. Continues to the system diagnosis after required system is selected by tapping the item in the Main Section.
Pause	Temporarily pauses scanning process.
ESC	Returns to the previous screen or exits Auto Scan.

9.5 Control Unit

This option allows you to manually locate a required control system for testing through a series of choices. Simply follow the menu-driven procedure, and make proper selection each time; the application will guide you to the diagnostic function menu after a few choices are made.

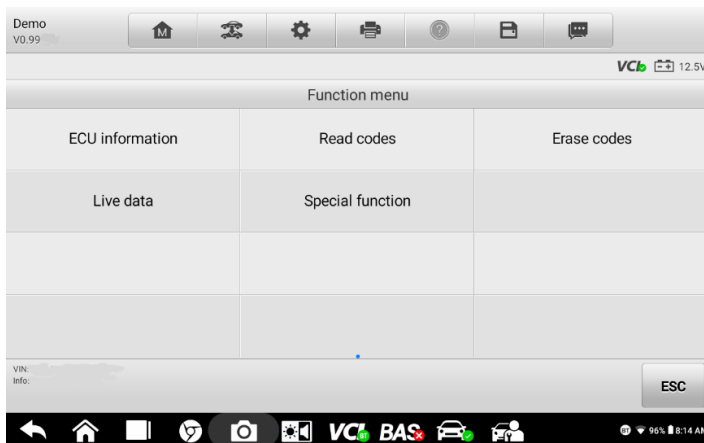

Figure 9-8 *Sample Function Menu Screen*

Available functions may vary by vehicle. The function menu may include:

- **ECU information** — displays detailed ECU information.
- **Read codes** — displays detailed DTC information retrieved from the vehicle control module.
- **Erase codes** — erases DTC records and other data from the vehicle's ECU.
- **Live data** — retrieves and displays live data and parameters from the vehicle's ECU.

9.5.1 Screen Messages

Messages display when additional input is needed before proceeding. There are three main types of on-screen messages: Confirmation, Warning, and Error.

- **Confirmation Messages**

These usually display as an “Information” screen, when you are about to perform an action that cannot be reversed or when an action has been initiated and your confirmation is needed to continue.

When a user-response is not required, the message will display only briefly.

- **Warning Messages**

These will display when the selected action may result in an irreversible change or loss of data. An example of this message is the “Erase Codes” message.

- **Error Messages**

These will display when a systemic or procedural error occurs. Possible errors include cable disconnection or communication interruption.

9.5.2 Making Selections

The Diagnostics application is a menu-driven program that presents a series of options, one at a time. As you select from a menu, the next menu in the series will display. Each selection narrows the focus and leads to the desired test. Use your fingertip to make menu selections.

9.6 ECU Information

This function retrieves and displays the specific information for the tested control unit, including unit type and version numbers.

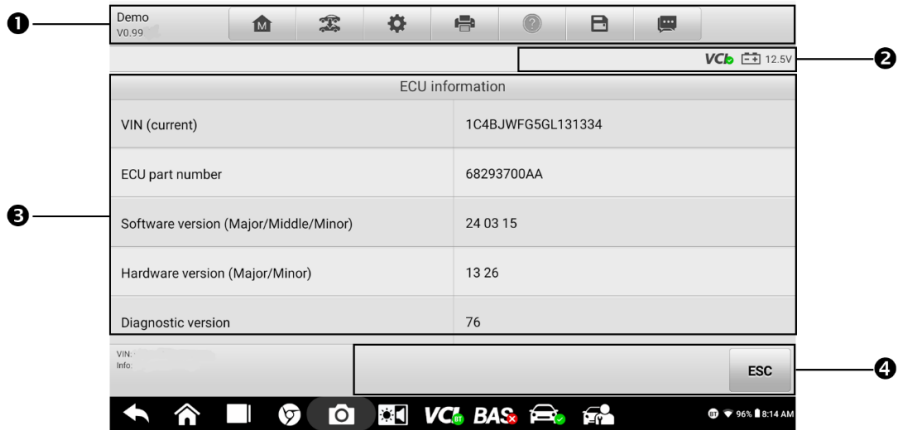

Figure 9-9 Sample ECU Information Screen

1. Diagnostics Toolbar (see [Table 9-2 Diagnostics Toolbar Buttons](#))
2. Status Information Bar
3. Main Section — the left column displays the item names, while the right column displays the specifications or descriptions.
4. Function Buttons — in this example, only an **ESC** button is available. Tap it to exit after viewing.

9.7 Read Codes

This function retrieves and displays the DTCs from the vehicle control system. The Read Codes screen varies for each vehicle being tested. For some vehicles, freeze frame data can also be retrieved for viewing. A sample Read Codes screen displays as below:

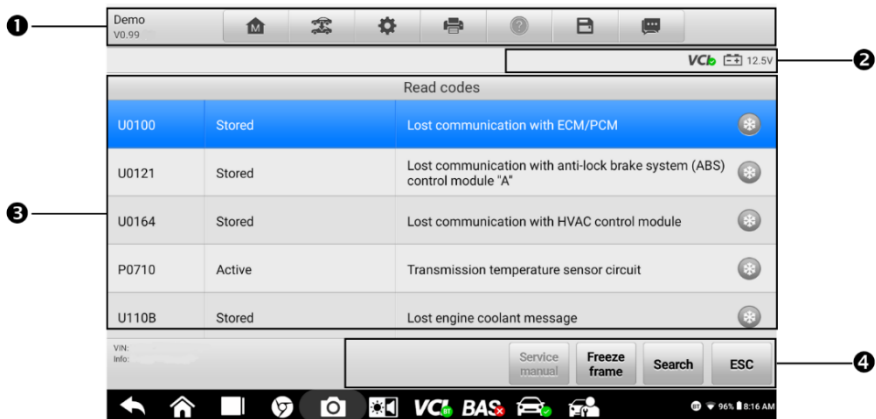

Figure 9-10 Sample Read Codes Screen

1. Diagnostics Toolbar (see [Table 9-2 Diagnostics Toolbar Buttons](#))
2. Status Information Bar
3. Main Section
 - ❖ Column 1 — displays retrieved codes from the vehicle.
 - ❖ Column 2 — indicates the status of the retrieved codes.
 - ❖ Column 3 — provides detailed descriptions for retrieved codes.
 - ❖ Column 4 — only displays when Freeze Frame data is available for viewing. Selecting this icon will display a data screen, which looks and behaves similar to the Read Codes screen.
4. Function Buttons
 - ❖ **Service Manual** — tap to view fault code information, repair instructions, and other help information.
 - ❖ **Freeze Frame** — a snowflake icon displays when freeze frame data is available for viewing. Tap the icon to display data screen. The Freeze Frame interface is similar to that of the Read Codes interface and shares similar operations.
 - ❖ **Search** — tap to search the selected DTC for additional information on the Internet.
 - ❖ **ESC** — tap to return to the previous screen or exit the function.

9.8 Erase Codes

After reading the retrieved codes from the vehicle and certain repairs have been made, you can erase the codes from the vehicle by using this function. Before performing this function, make sure the vehicle's ignition key is in the **ON** (RUN) position with the engine off.

➤ To erase codes:

1. Tap **Erase Codes** in the Function Menu.
2. A warning message will display to inform you of data loss when tapping this button.
 - a) Tap **Yes** to continue. A confirmation screen will display when the operation is successfully completed.
 - b) Tap **No** to exit.
3. Tap **ESC** on the confirmation screen to exit Erase Codes.
4. Check the Read Codes function again to ensure the operation is successful.

9.9 Live Data

When this function is selected, the screen will display the data list for the selected module. The parameters will display in the order that they are transmitted by the ECU, so expect variation among vehicles.

Gesture scrolling allows you to quickly move through the data list. Drag your finger up or down on the screen to reposition the parameters being displayed if the data occupies more than one screen. The figure below displays a typical Live Data screen:



Figure 9-11 Sample Live Data Screen

1. **Diagnostics Toolbar** — Tap the parallel menu icon at the top of the screen to display diagnostics toolbar buttons (see [Table 9-2 Diagnostics Toolbar Buttons](#)).
2. **Main Section**
 - ✧ Name Column — displays the parameters.
 - a) Check Box — tap the check box to the left of a parameter to select the item. Tap the check box again to deselect it.
 - b) Drop-down Button — tap the drop-down button on the right side of a parameter to open a submenu, which provides optional modes that display the data.
 - ✧ Value Column — displays the value of the parameters.
 - ✧ Range Column — displays the range of the parameters.
 - ✧ Unit Column — displays the unit for the parameter values.
 - To change the Unit mode, tap the **Setting** button in the top toolbar and select a required mode. See [Unit](#) on page 88.

3. Function Buttons

The operations of all available function buttons on the Live Data screen are described below:

- **Cancel All** — tap this button to cancel all selected parameters. Up to 50 parameters can be selected at one time.
- **Show Selected/Show All** — tap this button to switch between the two options. One displays the selected parameters, the other displays all available items.
- **Graph Merge** — tap this button to merge selected data graphs (for Waveform Graph Mode only). This function is very useful when comparing different parameters.

NOTE

This mode supports the merging of 2 to 5 parameters from different graphs. Only quantitative parameters are supported.

➤ **To merge selected data graphs:**

1. Select parameters to be merged.
2. Tap the **Graph Merge** button at the bottom of the Live Data screen.
 - a) This mode only supports quantitative parameters that can be represented digitally. If non-digital parameters are selected, a message will display advising the user that the selected parameters are not supported in this mode and to select 2 to 5 digital parameters. Tap **Got It** to return to the previous screen and select supported parameters.
 - b) When unsupported parameters are selected, a message will display advising the user to only select supported parameters. A message will also display if more than 5 parameters have been selected. Please select 2 to 5 supported parameters and tap the **OK** button to merge.
3. Tap the **Cancel Merging** button at the bottom of the Live Data screen to cancel merging.

- **To Top** — moves a selected data item to the top of the list.
- **Setting** — tap to set recording duration: From 5 seconds to 60 minutes.

➤ **To set live data record duration:**

1. Tap the **Setting** button at the bottom of the Live Data screen.
2. Tap the > button to the right of **Recording time after trigger** bar and select a time length.
3. Tap **OK** to save the settings and return to the Live Data Setting screen, or tap the “x” button on the upper-right corner to exit without saving.
4. Tap **Done** on the upper-right corner of the Live Data Setting screen to confirm and save the settings, and return to the Live Data screen, or tap **Cancel** to exit without saving.

- **Clear Data** — tap to clear all cached live data.

- **Freeze** — displays a still capture of retrieved data.
 - ✦ Resume — tap to exit the freeze data mode and return to live data display.
 - ✦ Previous Frame — moves to the previous frame of frozen data.
 - ✦ Play/Pause — tap to play/pause the frozen data.
 - ✦ Next Frame — moves to the next frame of frozen data.
- **Record** — starts recording the live data of the selected data items. Tap the **Record** button at the bottom of the Live Data screen. A message will display prompting the user to select parameters to record. Tap **Got It** to confirm. Scroll down and select data to record. Tap the **Record** button to start recording. Tap the **Resume** button to stop recording. The recorded live data can be viewed in the **Review** section at the bottom of the Live Data screen. The recorded data can also be reviewed in the Data Manager application.
 - ✦ Resume — Tap to stop data recording and to return to normal data display.
 - ✦ Flag — displays when the **Record** function is applied. Tap to set flags to mark points of interest when recording data. Notes can be added during playback in **Review** or **Data Manager**. Select the preset flag to open a pop-up window and display a virtual keyboard to enter notes.
- **Review** — reviews recorded data. Tap to display a list of recordings. Select an item to review.

 **NOTE**

Only data recorded during the current operation can be reviewed on the Live Data screen. All historical recorded data can be reviewed in Review Data in the Data Manager application.

- ✦ Graph Merge — merges selected data graphs.
 - ✦ Show Selected — displays the selected parameter items.
 - ✦ Previous Frame — moves to the previous frame of recorded data.
 - ✦ Play/Pause — tap to play/pause recorded data.
 - ✦ Next Frame — moves to the next frame of recorded data.
 - ✦ Back — exits the Review screen, and returns to the Live Data screen.
- **Back** — returns to the previous screen or exits the function.

Display Mode

There are four types of display modes available for data viewing, which allow you to view various types of parameters in the most suitable way.

Tap the drop-down button on the right side of a parameter to open a submenu. A total of seven buttons will be displayed: The four buttons on the left represent different data display modes, plus an **Information** button (active when additional information is available), an **Unit Change** button (for switching the unit of displayed data), and a **Trigger** button (tap to open the Trigger Settings window).

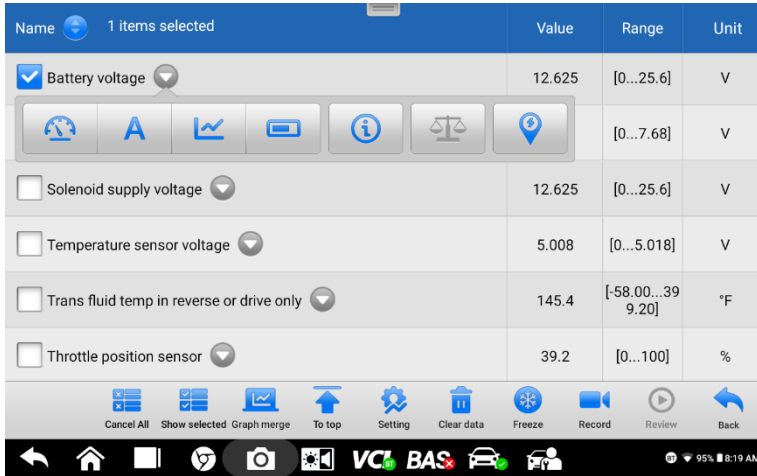

Figure 9-12 Sample Display Mode Screen

Each parameter item displays its selected mode independently.

- **Analog Gauge Mode** — displays the parameters in gauge charts.
- **Text Mode** — the default mode that displays the parameters as a text list.

NOTE

Status parameters, such as a switch reading like ON, OFF, TRUE, and FALSE, can only be displayed in Text Mode. Value parameters, such as a sensor reading, can be displayed in both text and graph modes.

- **Waveform Graph Mode** — displays the parameters in waveform graphs.

In this mode, five control buttons will display on the right side of the parameter item, allowing you to manipulate the display status.

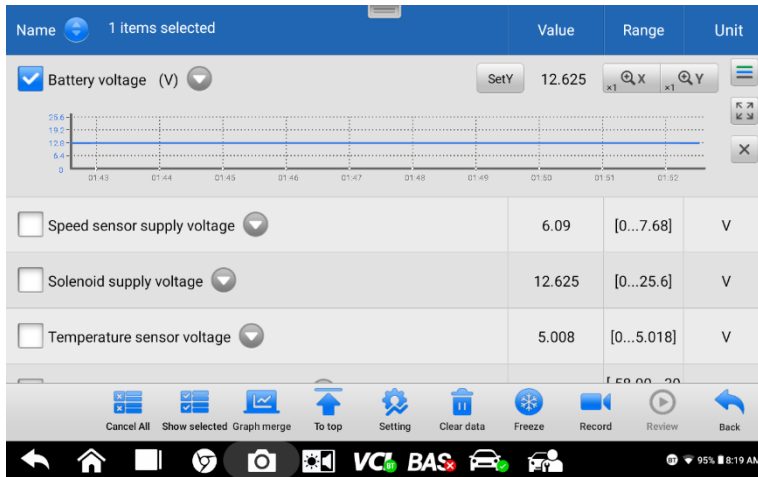

Figure 9-13 Sample Waveform Graph Mode Screen

1. **Settings Button (SetY)** — sets the minimum and maximum values of the Y axis.
2. **Scale Button** — changes the scale values.

There are two scale buttons displaying above the waveform graph to the right side, which can be used to change the scale values of the X axis and Y axis of the graph. There are four scales available for the X axis: x1, x2, x4 and x8, and three scales available for the Y axis: x1, x2, and x4.

3. **Edit Button** — edits the waveform color and the line thickness.
4. **Zoom-in Button** — tap to display the selected data graph in full screen.
5. **Exit Button** — tap to exit the waveform graph mode.

Full Screen Display — this option is only available in the waveform graph mode, and mostly used in Graph Merge status for data comparison. There are four control buttons available on the top-right side of the screen under this mode.

- Scale Button — tap to change the scale values below the waveform graph. There are four scales available for the X axis: x1, x2, x4 and x, and three scales available for the Y axis: x1, x2, and x4.
- Edit Button — tap to open an edit window, in which you can set the waveform color and the line thickness displayed for the selected parameter.
- Zoom-out Button — tap to exit full screen mode.
- Exit Button — tap to exit the waveform graph mode.

➤ **To edit the waveform color and line thickness in a data graph:**

1. Select parameters to display in Waveform Graph mode.
2. Tap the **Edit** Button, and an edit window will display.

3. The parameter is selected automatically in the left column.
4. Select a color from the second column.
5. Select a line thickness from the right column.
6. Tap **Done** to save the settings and exit, or tap **Cancel** to exit without saving.

 **NOTE**

In full screen mode, you can edit the waveform color and line thickness by tapping the **Edit** Button on the top-right corner of the screen.

- **Digital Gauge Mode** — displays the parameters in the form of a digital gauge graph.

Trigger Settings

Tap the drop-down button on the right side of a parameter to open a submenu. The **Trigger** button is the last one in the submenu. Tap to display the Trigger Settings window.

On the Trigger Settings screen, you can set a standard range by filling in a minimum value and a maximum value. When exceeding this range, the trigger function will be executed and the device will automatically record and save the generated data. You can review the saved live data by tapping the **Review** button at the bottom of the screen.

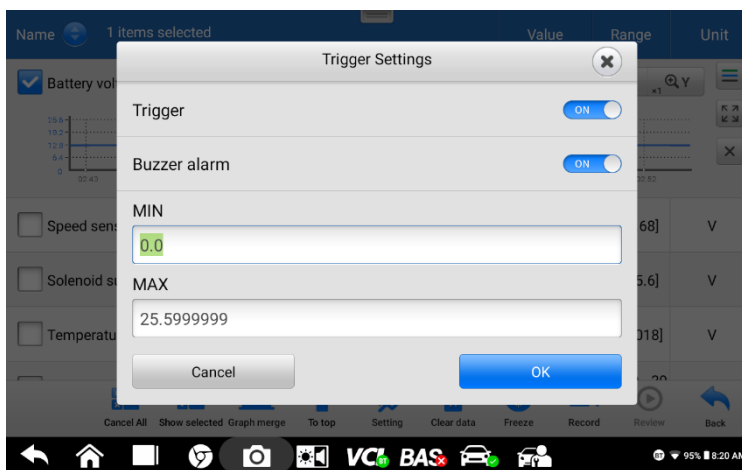

Figure 9-14 Sample Trigger Settings Screen

Two buttons and two input boxes are available in the **Trigger Settings** window.

- a) **Trigger On** — switches the trigger on and off. The trigger is **ON** by default.
- b) **Buzzer Alarm** — switches the alarm on and off. The alarm function makes a beeping sound to alert you when the data reading reaches the preset minimum or maximum values. The buzzer alarm will only sound at the first trigger.
- c) **MIN** — tap this input box to display a virtual keyboard to enter the required lower threshold value.
- d) **MAX** — tap this input box to display a virtual keyboard to enter the required upper threshold value.

➤ **To set a trigger:**

1. Tap the drop-down button on the right side of a parameter to open a submenu.
2. Tap the **Trigger** button on the right side of the submenu to open the Trigger Settings window.
3. Tap the **MIN** button on the right side, and enter the required minimum value.
4. Tap the **MAX** button on the right side, and enter the required maximum value.
5. Tap **OK** to save the settings and return to the Live Data screen, or tap **Cancel** to exit without saving.

When the trigger is set, a trigger mark will display in front of the parameter. The mark is gray when it is not triggered, and orange when triggered. Moreover, two horizontal lines display on each of the data graphs (when Waveform Graph Mode is applied) to indicate the alarm point. The threshold lines are shown in different colors to differentiate them from the parameter waveforms.

9.10 Active Test

The **Active Test** function is used to access vehicle-specific subsystem and component tests. Available tests vary by vehicle.

During an active test, the tablet sends commands to the ECU to activate the actuators. This test determines the integrity of the system or part by reading ECU data, or by monitoring the operation of the actuators. Such tests may include toggling between two positions of a solenoid, relay or switch.

Selecting **Active Test** displays a menu of available test options. Available tests vary by vehicle. Select a test from the menu options. Follow the instructions displayed on the screen to complete the test. Procedures and instructions vary by vehicle.

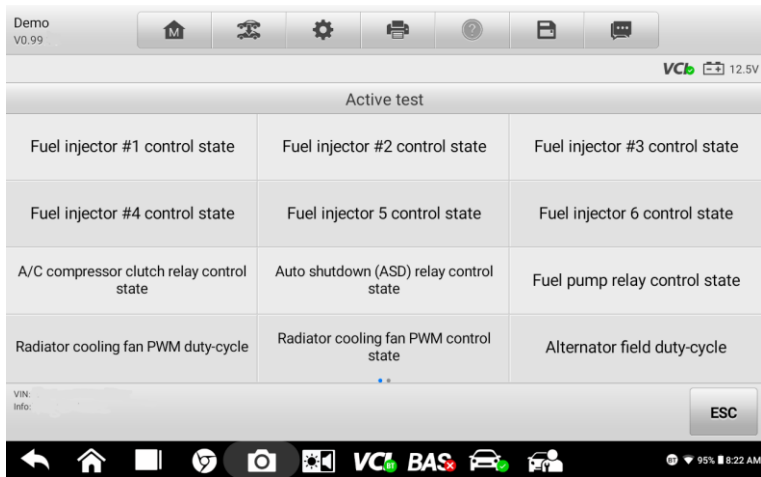

Figure 9-15 Sample Active Test Screen

The function buttons on the lower-right corner of the Active Test screen manipulate the test signals. Operational instructions are displayed in the main section of the test screen. Follow the on-screen instructions and make appropriate selections to complete the tests.

Tap the **ESC** button to exit the test when finished.

9.11 Generic OBDII Operations

OBDII/EODB vehicle diagnosis offers a quick way to check for DTCs, isolate the cause of an illuminated malfunction indicator lamp (MIL) on the dashboard, check monitor status prior to emissions certification testing, verify repairs, and perform other emissions-related services. The OBDII direct access option is also used for testing OBDII/EODB-compliant vehicles that are not included in the Diagnostics database. Diagnostics toolbar buttons at the top of the screen are available for specific vehicle diagnostics.

9.11.1 General Procedure

➤ **To access the OBDII/EODB diagnostics functions:**

1. Tap the **Diagnostics** application button in the MaxiBAS Job Menu. The Vehicle Menu will display.
2. Tap the **EOBD** button. There are two options for establishing communication with the vehicle.
 - Auto Scan — select to establish communication using each protocol in order to determine which one the vehicle is using.

- Protocol — select to open a submenu of available protocols. A communications protocol is a standardized way of data communication between an ECM and a diagnostic tool. Global OBD may use several different communications protocols.
3. Select a specific protocol if the **Protocol** option is selected. Wait for the OBDII Diagnostics Menu to appear.
 4. Select a function to continue. Supported functions may vary by vehicle.
 - DTC & FFD
 - I/M Readiness
 - Live Data
 - O₂ Sensor Monitor
 - On-Board Monitor
 - Component Test
 - Vehicle Information
 - Vehicle Status

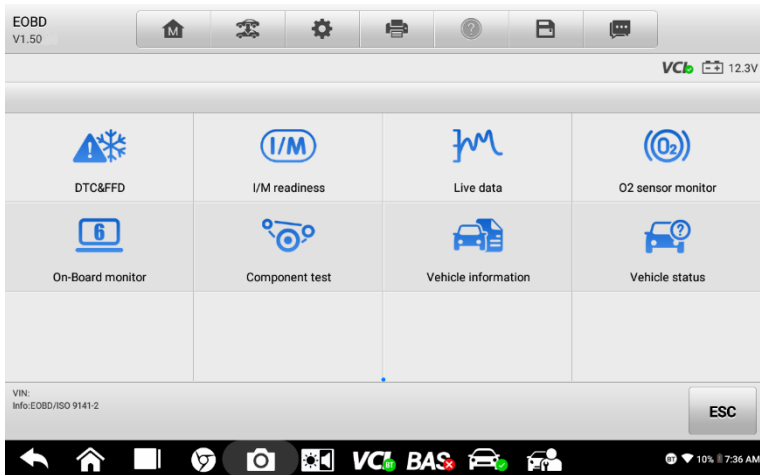

Figure 9-16 Sample OBDII Diagnostics Menu

9.11.2 Function Descriptions

This section describes the various functions of each diagnostic option:

DTC & FFD

When this function is selected, the screen displays a list of stored codes and pending codes. When the Freeze frame data of certain DTCs are available for viewing, a snowflake button will display on the right side of the DTC item. The Erase Codes function can be applied by tapping the function button at the bottom of the screen.

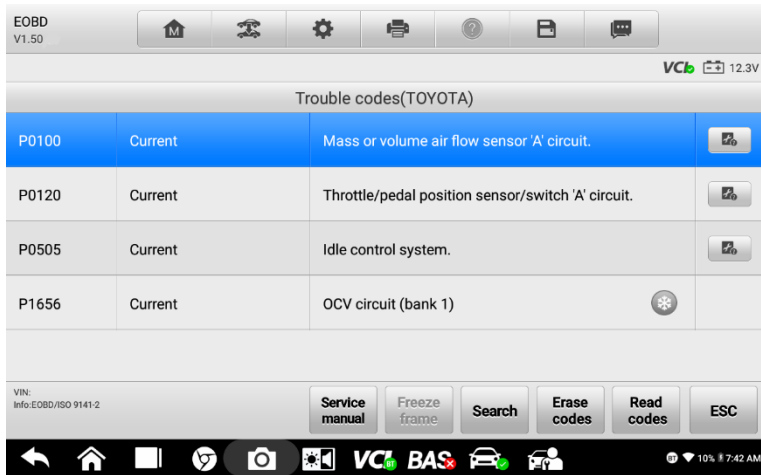

Figure 9-17 Sample DTC & FFD Screen

- **Current Codes**

Current codes are emission-related DTCs from the ECU of the vehicle. OBDII/EOBD codes are prioritized according to their emissions severity, with higher-priority codes overwriting lower-priority ones. The priority of the code determines the illumination of the Malfunction Indicator Light (MIL) and the codes erase procedure. Manufacturers rank codes differently, so expect the display to vary by vehicle.

- **Pending Codes**

These are codes whose storing conditions have been met during the last drive cycle, but need to be met on two or more consecutive drive cycles before the DTC is stored. The purpose of displaying pending codes is to assist the service technician after a vehicle repair when diagnostic information is cleared, by reporting test results after a single drive cycle.

- If a test fails during the drive cycle, the DTC associated will be reported. If the pending fault does not occur again within 40 to 80 warm-up cycles, the fault is automatically cleared from memory.
- Test results reported do not necessarily indicate a faulty component or system. If test results indicate another failure after additional driving, a DTC is stored to indicate a faulty component or system.

- **Freeze Frame**

In most cases, the stored frame is the last DTC reported. Certain DTCs — those that have a greater impact on vehicle emission — have a higher priority. In these cases, DTCs of the highest priority will be retained. Freeze frame data includes a “snapshot” of critical parameter values at the time the DTC is stored.

- **Erase Codes**

This option is used to clear all emission-related diagnostic data including DTCs, freeze frame data and specific manufacturer-enhanced data from the vehicle ECU. This option resets the I/M Readiness Monitor Status for all vehicle monitors to Not Ready or Not Complete status.

A confirmation screen will display when the clear codes option is selected to prevent accidental loss of data. Tap **Yes** on the confirmation screen to continue, or **No** to exit.

I/M Readiness

This function is used to check the readiness of the monitoring system. It is an excellent function to use prior to having a vehicle inspected for local emissions compliance. Selecting I/M Readiness opens a submenu with two choices:

- Since DTCs Cleared — displays the status of monitors since the last time the DTCs were erased.
- This Drive Cycle — displays the status of monitors since the beginning of the current drive cycle.

Live Data

This function enables the display of real-time PID data from the ECU. Displayed data includes analog and digital input and output, and system status information broadcast in the vehicle data stream.

Live data can be displayed in various modes. See [Live Data](#) on page 53 for detailed information.

O₂ Sensor Monitor

This function allows the retrieval and review of recent O₂ sensor monitor test results stored on the vehicle's on-board computer.

The O₂ Sensor Monitor test function is not supported by vehicles that communicate using a Controller Area Network (CAN). For O₂ Sensor Monitor tests results of CAN-equipped vehicles, refer to On-Board Monitor below.

On-Board Monitor

This function allows you to view the results of On-Board Monitor tests. The tests are useful after the service when a vehicle's control module memory is already erased.

Component Test

This function enables dual-directional control of the ECU so that the diagnostics tool can transmit control commands to operate the vehicle systems. This function is useful in determining how well the ECU responds to a command.

Vehicle Information

This function enables the display of the vehicle identification number (VIN), calibration identification number, Calibration Verification Number (CVN), and other vehicle information.

Vehicle Status

This function checks the current condition of the vehicle, such as the communications protocols of OBDII modules, quantity of fault codes, and the status of the Malfunction Indicator Light (MIL).

9.12 Diagnostic Report

The diagnostic report can be reviewed, saved, and printed in multiple applications on the MaxiBAS diagnostics platform.

1. Via the History function:

- Enter the **Diagnosis** main screen, and tap **History** on the Top Toolbar.
- Select a history record and tap the **ellipsis** **...** button on the upper-right corner to view the PDF document, and print, email or delete the test record.

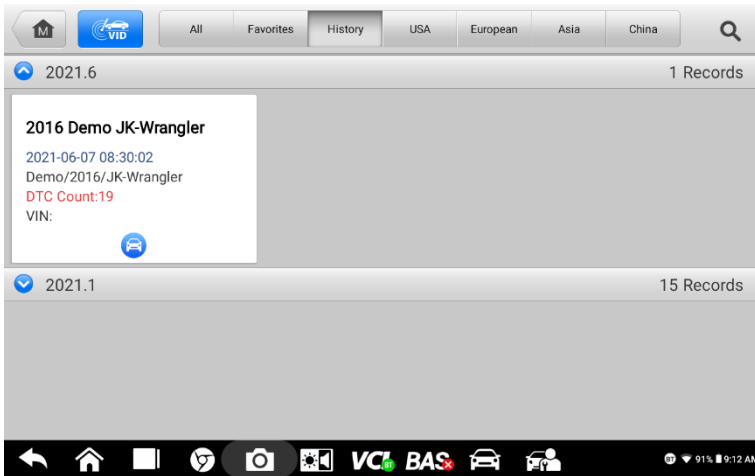



Figure 9-18 Sample History Screen

2. Via the Auto Scan function:

- Tap **Auto Scan** on the Diagnostics Menu screen to automatically scan the vehicle systems.
- When the system scan is completed, tap **Report** at the bottom of the screen.

- Tap the  button on the Diagnostics Toolbar, and select **Save all data** to save a PDF document or select **Save this page** to save the screenshot of the current page.

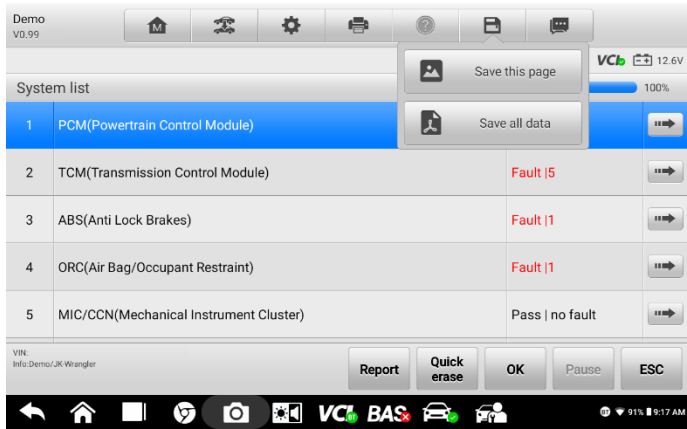



Figure 9-19 Sample Auto Scan Screen

3. Via the buttons on the navigation bar:

The diagnostic report can also be viewed from the Read Codes and Live Data screens. Tap the  button on the Diagnostics Toolbar, and select **Save all data** to save a PDF document or select **Save this page** to save a screenshot of the current page.

9.13 Exit Diagnostics

The **Diagnostics** application operates while the communication between the tablet and the vehicle is still active. It is important to properly exit from the diagnostics operation interface to stop all communications with the vehicle before closing the **Diagnostics** application.

NOTE

Damage to the vehicle electronic control module (ECM) may occur if communication is disrupted. Ensure all forms of communication links, such as data cable, USB cable, and wireless or wired network, are properly connected throughout the test. Exit all interfaces before disconnecting the test cable and power supply.

➤ **To exit the Diagnostics application:**

On an active diagnostic screen, tap the **Back** or **ESC** button to exit a diagnostic session;

Or

1. Tap the **Vehicle Swap** button on the diagnostics toolbar to return to the Vehicle Menu screen.
2. On the Vehicle Menu screen, tap the **Home** button on the top toolbar, or tap the **Back** button on the navigation bar at the bottom of the screen.

Or

Tap the **Home** button on the diagnostics toolbar to exit the application directly and return to the MaxiBAS Job Menu.

Now, the Diagnostics application is no longer communicating with the vehicle and it is safe to open other applications or exit the MaxiBAS Diagnostics System and return to the Android Home screen.

10 Service

The **Service** section is specially designed to provide quick access to the vehicle systems for various scheduled service and maintenance tasks. The typical service operation screen is a series of menu-driven commands. Follow the on-screen instructions to select appropriate options, enter values or data, and perform necessary actions. The application will display detailed instructions to complete selected service operations.

After entering each special function, the screen will display two application choices: **Diagnosis** and **Hot Functions**. **Diagnosis** enables the reading and clearing of codes, which is sometimes necessary after completing certain special functions. **Hot Functions** consists of sub functions of the frequently used special function(s).

In this chapter, we will discuss several of the most commonly used services.

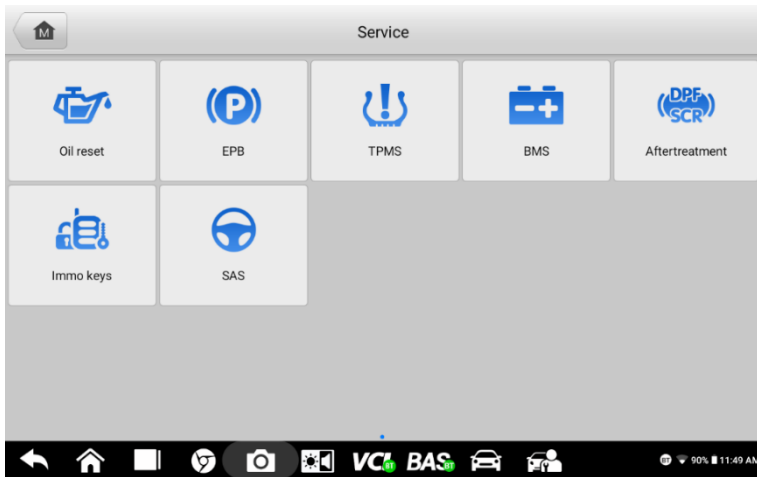

Figure 10-1 Sample Service Menu

10.1 Oil Reset Service

This function performs a reset of the Engine Oil Life system, which calculates the optimal oil life change interval depending on the vehicle driving conditions and climate. The Oil Life Reminder must be reset each time the oil is changed so that the system can calculate when the next oil change is required.

NOTE

1. Always reset the engine oil life to 100% after every oil change.
 2. All required work must be carried out before the service indicators are reset. Failure to do so may result in incorrect service values and cause DTCs to be stored by the relevant control module.
 3. For some vehicles, the scan tool can reset additional service lights such as the maintenance cycle and service interval. On BMW vehicles for example, service resets include engine oil, spark plugs, front/rear brakes, coolant, particle filter, brake fluid, micro filter, vehicle inspection, exhaust emissions inspection, and vehicle checks.
-

10.2 Electric Parking Brake (EPB) Service

This function has a multitude of ways to maintain the electronic braking system including activating and deactivating the brake control system, assisting with brake fluid control, opening and closing brake pads, and calibrating brakes after disc or pad replacement.

EPB Safety

It can be dangerous to perform EPB system maintenance.

Before you begin the service work, please keep the following rules in mind!

- Ensure that you are familiar with the braking system and its operation before commencing any work.
- The EPB control system may require deactivation before carrying out any maintenance/diagnostic work on the brake system. This can be done from the tool menu.
- Only perform maintenance work when the vehicle is stationary and on level ground.
- Ensure that the EPB control system is reactivated after the maintenance work has been completed.

NOTE

Autel accepts no responsibility for any accident or injury arising from the maintenance of the EPB system.

10.3 Tire Pressure Monitoring System (TPMS) Service

This function allows you to quickly look up the tire sensor IDs from the vehicle's ECU and to perform TPMS replacement and reset procedures after tire sensors are replaced.

10.4 Battery Management System (BMS) Service

The BMS allows the tool to evaluate the battery charge state, monitor the closed-circuit current, register the battery replacement, activate the rest state of the vehicle, and charge the battery via the diagnostic socket.

NOTE

1. This function is not supported by all vehicles.
2. The sub functions and actual test screens of the BMS may vary by vehicle. Please follow the on-screen instructions to make correct selection.

The vehicle may use either a sealed lead-acid battery or an Absorbed Glass Mat (AGM) battery. Lead acid batteries contain liquid sulphuric acid and can spill when overturned. AGM batteries (valve regulated lead acid, VRLA batteries) also contains sulphuric acid, but the acid is contained in glass mats between terminal plates.

It is recommended that the replacement aftermarket battery has the same specifications, such as capacity and type, as the original battery. If the original battery is replaced with a different type of battery (e.g., a lead-acid battery is replaced with an AGM battery) or a battery with a different capacity (mAh), the vehicle may require reprogramming of the new battery in addition to performing the battery reset. Consult the vehicle manual for additional vehicle-specific information.

10.5 Diesel Particle Filter (DPF) Service

The DPF function manages DPF regeneration, DPF component replacement teach-in and DPF teach-in after replacing the engine control unit.

The ECM monitors driving style and selects a suitable time to employ regeneration. Cars driven a lot at idling speed and low load will attempt to regenerate earlier than cars driven more with higher load and speed. In order for regeneration to take place, a prolonged high exhaust temperature must be obtained.

In the event of the car being driven in such a way that regeneration is not possible, i.e., frequent short journeys, a DTC will eventually be registered in addition to the DPF light and "Check Engine" indicators. A service regeneration can be requested in the workshop using the diagnostic tool.

Before performing a forced DPF regeneration using the tool, check the following items:

- The fuel light is not on.
- No DPF-relevant faults are stored in system.
- The vehicle has the specified engine oil.
- The oil for diesel is not contaminated.

IMPORTANT

Before diagnosing a problem vehicle and attempting to perform an emergency regeneration, it is important to obtain a full diagnostic log and read out relevant measured value blocks.

NOTE

1. The DPF will not regenerate when the engine management light is on or when there is a faulty EGR valve.
 2. The ECU must be re-adapted when replacing the DPF and when topping up the fuel additive Eolys.
 3. If the vehicle needs to be driven in order to perform a DPF service, a second person is required for the function: One person should drive the vehicle while the other person observes the screen on the tool. Do not attempt to drive and observe the scan tool at the same time. This is dangerous and puts your life and the lives of other motorists and pedestrians at risk.
-

10.6 Immobilizer (IMMO) Service

An immobilizer is an anti-theft mechanism that prevents an automobile's engine from starting unless the correct ignition key or other device is present. This device prevents thieves from starting the car by a method known as hot wiring. Most new vehicles have an immobilizer as standard equipment. An important advantage of this system is that it doesn't require the car owner to activate it; it operates automatically. An immobilizer is considered as providing much more effective anti-theft protection than an audible alarm alone; many auto insurance companies offer lower rates for vehicles that are equipped with an immobilizer.

As an anti-theft device, an immobilizer disables one of the systems needed to start a car's engine, usually the fuel supply or the ignition. This is accomplished by radio frequency identification between a transponder in the ignition key and a radio frequency reader in the steering column. When the key is placed in the ignition, the transponder sends a signal with a unique identification code to the reader, which relays it to a receiver in the vehicle's computer control module. If the code is correct, the computer allows the fuel supply and ignition systems to operate and start the engine. If the code is incorrect or absent, the computer disables the system, and the engine will be unable to start until the correct key is placed in the ignition.

The IMMO service can disable a lost vehicle key and program the replacement key fob. One or more replacement key fobs can be programmed.

10.7 Steering Angle Sensor (SAS) Service

Steering Angle Sensor (SAS) Calibration permanently stores the current steering wheel position as the straight-ahead position in the SAS EEPROM. Therefore, the front wheels and the steering wheel must be set exactly to the straight-ahead position before calibration. In addition, the VIN is also read from the instrument cluster and stored permanently in the SAS EEPROM. On successful completion of calibration, the SAS fault memory is automatically cleared.

Calibration must always be carried out after the following operations:

- Steering wheel replacement
- SAS replacement

- Any maintenance that involves opening the connector hub from the SAS to the column
 - Any maintenance or repair work on the steering linkage, steering gear or other related mechanism
 - Wheel alignment or wheel track adjustment
 - Accident repairs where damage to the SAS, SAS assembly, or any part of the steering system may have occurred
-

 **NOTE**

1. Autel accepts no responsibility for any accident or injury arising from servicing the SAS system. When interpreting DTCs retrieved from the vehicle, always follow the manufacturer's recommendation for repair.
 2. All software screens shown in this manual are examples, and actual test screens may vary by test vehicle. Pay attention to the menu titles and the on-screen instructions to make correct option selections.
 3. Before starting any procedure, make sure the vehicle has an **ESC** button. Look for the button on the vehicle dashboard.
-

11 Multimeter

The multimeter (sold separately) is a multi-function, multi-range measuring instrument. Connect the multimeter to the B200 device and access its applications directly from the BT609 Home screen to perform leakage detection, relative compression test, and basic functions, including AC/DC voltage, AC/DC current, resistance measurements, diode, and connectivity tests. The test results will be displayed by numeric values or graphs.

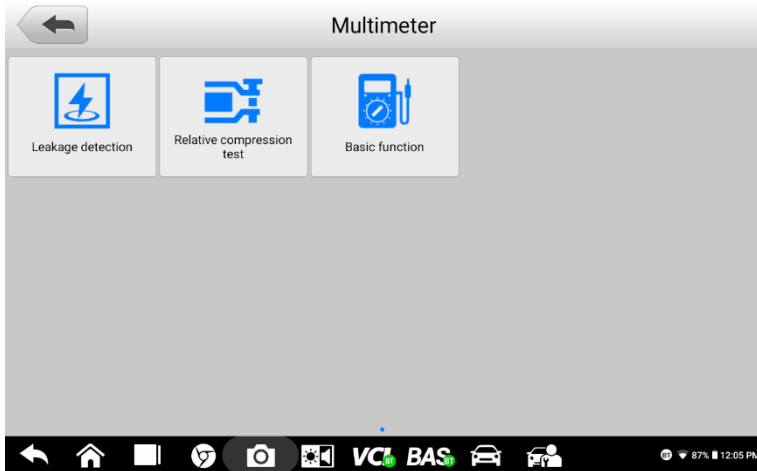

Figure 11-1 Sample Multimeter Home Screen

11.1 Safety Information

Follow the instructions below to reduce the risk of injury from electric shock and prevent equipment damage.

- Use the multimeter only as specified in this manual.
- Do not apply more than the rated voltage between connectors or between any connector and ground.
- Do not input a value beyond the maximum range when measuring. Remember that the maximum range of this multimeter is 200V.
- To prevent injury or death, do not use the multimeter if it appears to be damaged in any way, and stop use immediately if you are concerned with any abnormal operations.
- To prevent injury or death, never ground yourself when taking electrical measurements. Isolate yourself from ground by using dry rubber insulating mats to cover all exposed/grounded metal. Ensure all clothing, including gloves, are dry. Stand on rubber mats when using the tool.

- Use the test leads or probes supplied with the product, or compatible terminals. Inspect the test leads or probes for damage before use.
- When using probes, keep fingers behind the finger guards on the probes.
- Use the supplied replacement fuses or specified replacement parts.
- Always consider electrical and electronic equipment to be energized (live). Never assume any equipment is de-energized.
- When making electrical connections, connect the common test lead before connecting the live test lead; when disconnecting, disconnect the live test lead before disconnecting the common test lead.
- When measuring current, turn off circuit power before connecting the multimeter to the circuit. Remember to place the multimeter in series with the circuit.
- After current measurement is finished, turn off the power to the circuit before removing the test leads and before reconnecting any disconnected wires or devices.
- Do not add voltage to the input terminal when measuring resistance.
- To avoid electric shock, turn off the power to the component before connecting.
- To prevent damage, always use and store your multimeter in appropriate environments.
- Do not use in wet or damp conditions or around explosive gas or vapor.
- Do not tamper with or disassemble the multimeter, connectors or accessories. Internal damage will affect performance.
- Before carrying out maintenance and cleaning of the multimeter, make sure the unit is NOT connected to a power source, vehicle or computer.
- When cleaning the multimeter, use a damp, soft cloth with mild detergent. Do not allow water to enter the multimeter casing.

11.2 Connecting the Multimeter

1

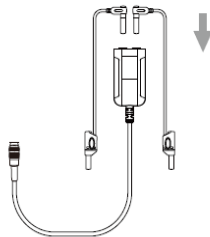

- Plug the red test lead into the red color coded input of the multimeter, and the black test lead into the black input.

2

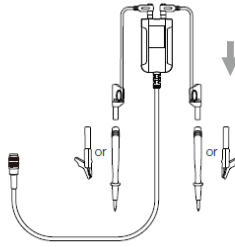

- Connect the red alligator clip/red probe to the other end of the red test lead, and the black alligator clip/black probe to the black test lead.

3

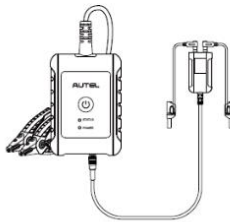

- Power on the BT609 and tap the **Multimeter** button to enter the application.
- Connect the multimeter to the multimeter cable port of the MaxiBAS B200 series tester and tighten the connector of the multimeter.

4

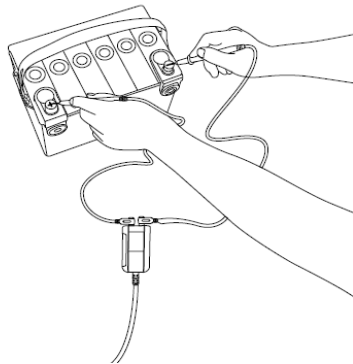

- Now the multimeter is ready for use.

11.3 Leakage Detection

Before opening the **Multimeter** application, ensure the multimeter device (DM100, Digital Multimeter 100) is connected to the tester via the multimeter cable. The device will beep when entering the application after properly connected with the tester.

Some current will flow through the protective ground conductor to ground in an electrical installation. This is often called leakage current. Leakage current may cause unnecessary and intermittent tripping of circuits protected by ground fault current interrupters. High levels of leakage current may be present in circuits where electronic equipment with filters is used, and can cause voltages that disrupt normal operation of equipment. In order to eliminate or minimize the effects of leakage current, a current clamp meter can be used.

Under Leakage detection, two models are available: Current model and Multimeter model.

11.3.1 Current Model

The Current model can detect leakage current on a whole battery. Check the vehicle manufacturer manual for the static current parameter so as to verify leakage current. Please follow the step-by-step instructions on the screen to complete the test.

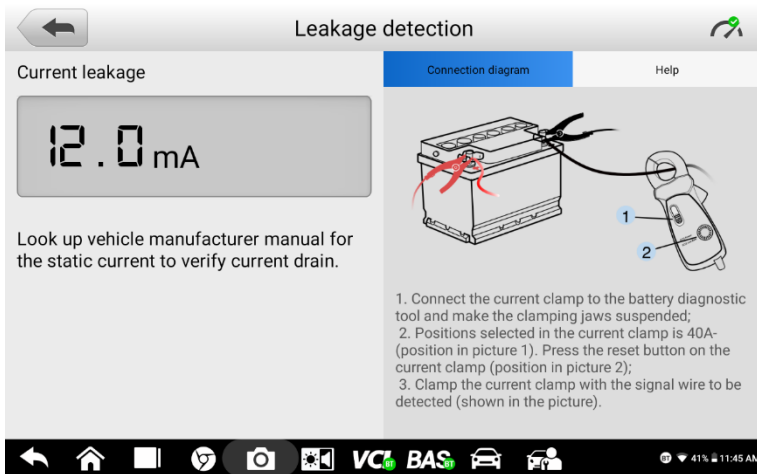

Figure 11-2 Sample Leakage Detection (Current Model) Screen

11.3.2 Multimeter Model

The Multimeter model can detect leakage current on a specific fuse. Select the corresponding fuse type and color to initiate the test.

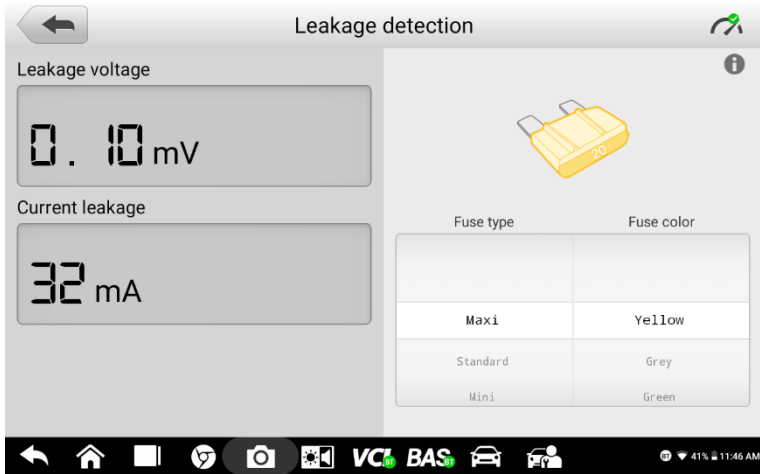

Figure 11-3 Sample Leakage Detection (Multimeter Model) Screen

! IMPORTANT

Before performing leakage detection, ensure that the battery voltage is above 12.6 V; otherwise, the engine should be turned on to charge the battery. The test result may be compromised if the battery voltage is below 12.6 V.

11.4 Relative Compression Test

The Relative compression test is helpful to diagnose misfires due to a compression issue. By applying a low amp probe, this test will show the compression in the cylinders, not actual values but relative to each other, so the user can identify which cylinder may have the low compression. Follow the on-screen instructions to prepare for the test.

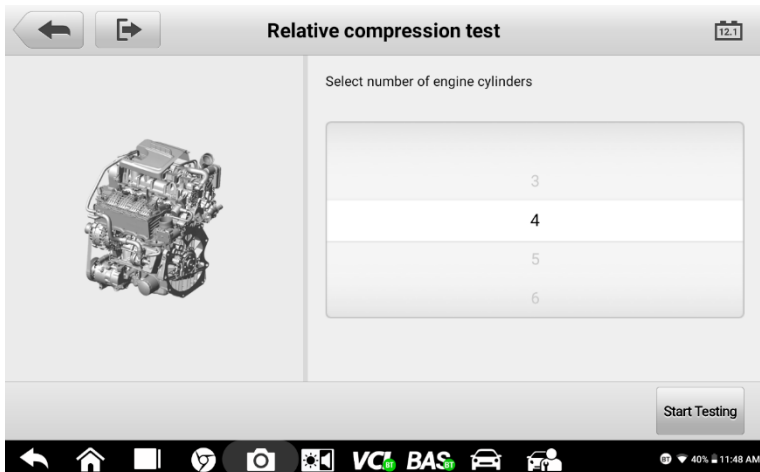

Figure 11-4 Sample Relative Compression Test Screen

11.5 Basic Function

Basic functions give the user access to tests that cover AC/DC voltage, AC/DC current, resistance measurements, diodes, and connectivity.

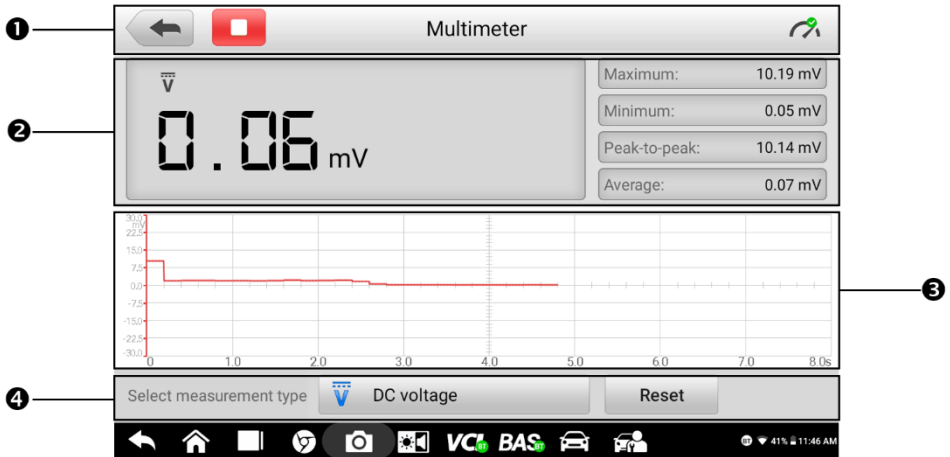





Figure 11-5 Sample Multimeter Screen

11.5.1 Screen Layout and Operation

1. Upper Toolbar Buttons and Multimeter Icon
2. Digital Display
3. Main Section
4. Measurement Type Selection and **Reset** Button

1. Buttons and Multimeter Icon

Button/Icon	Description
	Tap to return to the previous screen.
	Tap to pause or resume the multimeter test.
	This icon indicates the connection status with the tester. A green check mark means that the tester and the multimeter are connected; a red "x" means that the device and the tester are not connected.
	Tap to clear the current multimeter test results.

2. Digital Display

This section displays the digital measurement results.







3. Main Section

The Main Section features a coordinate grid with the X-axis representing the time duration and the Y-axis representing the amplitude level.

4. Measurement Type Selection

This multimeter can be used to measure AC voltage, DC voltage, resistance, AC electricity, DC electricity, diodes, and connectivity.

The measurement types include:

Icon	Name	Description
	AC voltage	Measures the voltage in the electrical circuit.
	DC voltage	
	Resistance	Measures the resistance of the electrical circuit or the component.
	AC current	Measures current amperage by using the optional current clamp.
	DC current	
	Diode	Conducts a diode test of the electrical circuit.
	Connectivity	Determines whether a low impedance exists two points in the electrical circuit. If the impedance is less than 100 ohms, the circuit is “closed”; otherwise, the circuit is “open”.

NOTE

1. AC/DC current is measured with clamps, while AC/DC voltage, diode, and connectivity are measured with probes.
2. When selecting the **Resistance** measurement type, the self-calibration mark  will display beside **Resistance**, indicating the multimeter will turn zero in order to improve accuracy.
3. When measuring AC/DC current, different measuring ranges require different operations of the clamp. Follow the on-screen instructions to connect the clamp properly.

12 Data Manager

The Data Manager allows you to store, print, and review saved files, manage workshop information, customer information records, and store test vehicle history records.

Selecting the Data Manager opens the file system menu. There are eight functions available.

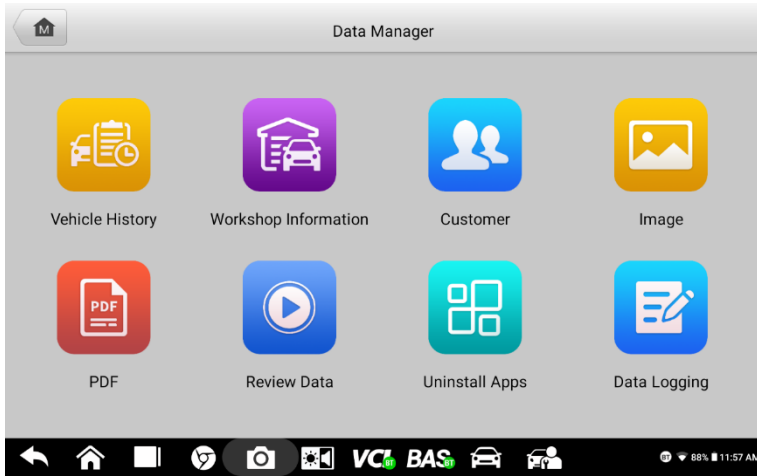



Figure 12-1 Sample Data Manager Main Screen

The table below briefly describes the function buttons in the Data Manager.

Table 12-1 Buttons in Data Manager

Name	Button	Description
Vehicle History		Tap to review the diagnostic history.
Workshop Information		Tap to edit the workshop profile information.
Customer		Tap to create a new customer account file.
Image		Tap to review saved screenshots.
PDF		Tap to review diagnostic reports.
Review Data		Tap to review recorded data.

Name	Button	Description
Uninstall Apps		Tap to uninstall applications.
Data Logging		Tap to review communications data and ECU information for the test vehicle. The saved data can be sent to the technical center via the Internet for review and for possible resolution.

12.1 Vehicle History

This function stores vehicle test records, including vehicle information and the retrieved DTCs from previous diagnostic sessions. Test information is summarized and displayed in an easy-to-read table listing. The **Vehicle History** also provides direct access to the previously tested vehicle and allows you to directly restart a diagnostic session without needing to perform auto or manual vehicle selection.

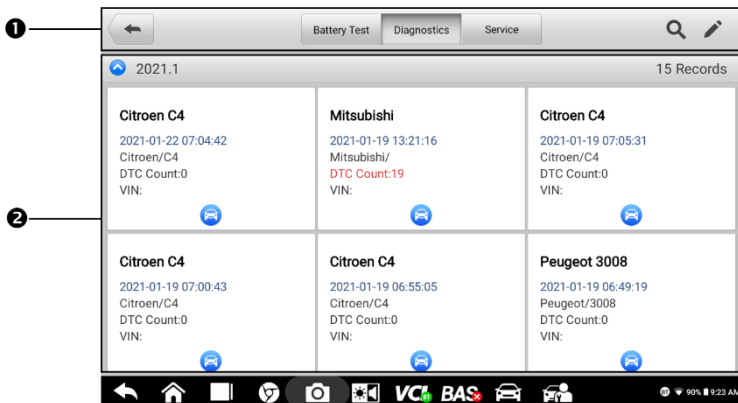

Figure 12-2 Sample Vehicle History Screen

1. Top Toolbar Buttons — navigation and application controls.
2. Main Section — displays all the vehicle test records.

➤ **To activate a test session for a recorded vehicle:**

1. Tap **Data Manager** on the MaxiBAS Job Menu.
2. Select **Vehicle History** to open the screen. Tap **Diagnostics** or **Service** to select diagnostic test records or service test records.
3. Tap the **Diagnostics** icon at the bottom of the thumbnail of a vehicle record.
4. The Diagnostics screen of the vehicle will display and a new diagnostic session will be activated. See [Diagnostics](#) for detailed instructions on vehicle diagnostic operations.

Or

Select a vehicle thumbnail and choose a record. A Test History record sheet will display. Review the recorded information for the test vehicle, and tap the **Diagnostics** button on the upper-right corner to continue diagnostics.

NOTE

The BT609 tablet must establish a connection to the VCI device to restart test sessions on previously tested vehicles.

12.1.1 Historical Test Records

The Historical test is a detailed data form for the tested vehicle, which includes general vehicle information, service records, customer information, and the diagnostic trouble codes retrieved from previous test sessions. Technician Notes will also be displayed, if present.

Vehicle information	
Year	License plate
Make Citroen	VIN
Model C4	Odometer Mileage
Sub model C4 (B7)	Color
Engine	Status Not started

Figure 12-3 Sample Historical Test Record Sheet

➤ **To edit the Historical Test Record:**

1. Tap **Data Manager** on the MaxiBAS Job Menu.
2. Select **Vehicle History**.
3. Select the specific vehicle record thumbnail from the main section. The **Historical Test Record** will display.
4. Tap **Edit** (the pen icon) to edit the record.
5. Tap each item to enter information or attach data files or images.
6. Tap **Add to Customer** to correlate the Historical Test record with an existing customer account, or add a new associated account to be correlated with the test vehicle record. See [Customer](#) for more information.
7. Tap **Done** to save the updated record, or tap **Cancel** to exit without saving.

12.2 Workshop Information

The **Workshop Information** form allows you to enter, edit, and save detailed workshop profile information, such as shop name, business address, phone number, and other remarks, which, when printing vehicle diagnostic reports and other associated test files, will display as the header of the printed documents.

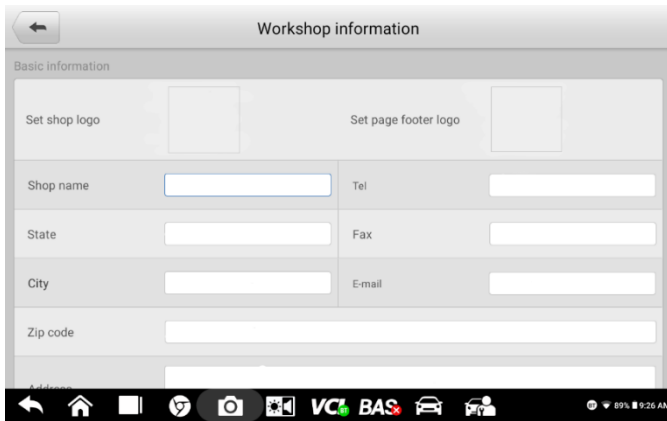

Figure 12-4 *Sample Workshop Information Sheet*

➤ To edit your Workshop Information:

1. Tap the **Data Manager** application on the MaxiBAS Job Menu.
2. Select **Workshop Information**.
3. Tap on each field to enter the appropriate information.
4. Tap **Done** to save the updated workshop information record, or tap **Cancel** to exit without saving.

12.3 Customer

The **Customer** function allows you to create and edit customer accounts. It helps you to save and organize your customer information accounts which can then be correlated with the associated test vehicle records.

➤ To create a customer account:

1. Tap the **Data Manager** application on the MaxiBAS Job Menu.
2. Select **Customer**.
3. Tap the **Add a customer** button. A blank information form will display. Tap each field to enter the appropriate information.
4. Some customers may have more than one vehicle for service; you can always add new vehicle information to a customer account. Tap **Add new vehicle information**, and then fill in the vehicle information.
5. Tap **Complete** to save the account, or tap **Cancel** to exit without saving.

➤ **To edit a customer account:**

1. Tap **Data Manager** on the MaxiBAS Job Menu.
2. Select **Customer**.
3. Select a customer account by tapping the corresponding name card. A **Customer Information** record will display.
4. Tap **Edit** on the top toolbar to edit the record.
5. Tap on the enter field to edit the information, and enter updated information.
6. Tap **Complete** to save the updated information, or tap **Cancel** to exit without saving.

➤ **To delete a customer account:**

1. Tap **Data Manager** on the MaxiBAS Job Menu.
2. Select **Customer**.
3. Select a customer account by tapping the corresponding name card. A **Customer Information** record will display.
4. Tap **Edit** on the top toolbar to edit the record.
5. Tap the **Delete** button on the top of the screen. A reminder will display.
6. Tap **OK** to confirm the message and the account will be deleted, or tap **Cancel** to cancel the request.

12.4 Image

The Image section is a database containing all captured screenshots.

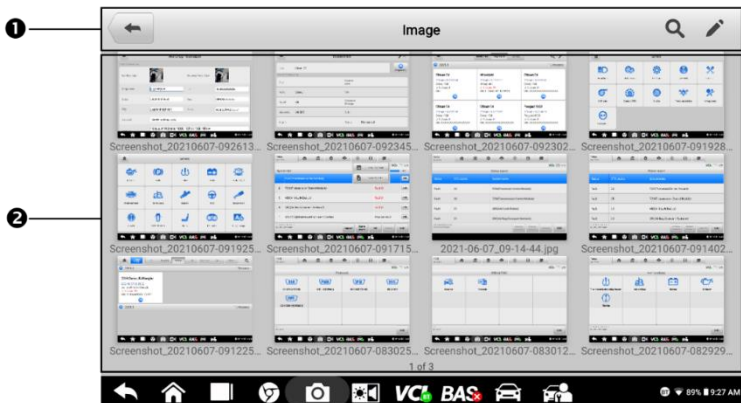



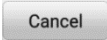





Figure 12-5 Sample Image Database Screen

1. **Toolbar Buttons** — used to edit, print or delete image files.
2. **Main Section** — displays stored images.

Table 12–2 *Toolbar Buttons in Image Database*

Name	Button	Description
Back		Tap to return to the previous screen.
Enter Search		Enter the search page.
Enter Edit		Display the editing toolbar to select, delete, print, or email images.
Cancel		Close the editing toolbar or cancel file search.
Search		Quickly searches for an image by entering the time of the screenshot.
Print		Prints the selected image.
Delete		Deletes the selected image.
Email		Attaches the selected image to an email message.

➤ **To edit/delete images:**

1. Select **Data Manager** from the MaxiBAS Job Menu.
2. Select **Image** to access the image database.
3. Tap **Edit** on the top-right corner of the screen. The editing screen will display.
4. Select the image(s) you want to edit by tapping the check box on the bottom-right corner of the image.
5. Tap the **Delete** icon to delete the selected images or delete all images. Tap the **Print** icon to print the selected image(s). Tap the **Email** icon to send the selected images to an email address.

12.5 PDF Files

The PDF section stores and displays all PDF files of saved data. After entering the PDF database, select a file to view.

This section uses the standard Adobe Acrobat Reader application for file viewing and editing. Please refer to the Adobe Acrobat Reader manual for more detailed instructions.

12.6 Review Data

The Review Data section allows you to play back recorded data frames from live data. On the Review Data main screen, select a record to play back.

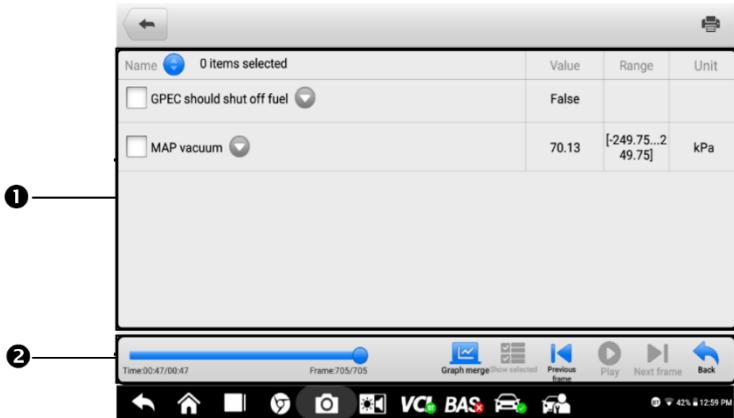

Figure 12-6 Sample Review Data Screen

1. Main Section — displays the recorded data frames.
 2. Navigation Toolbar — allows you to manipulate data playback.
- Use the Navigation Toolbar buttons to play back the record data from frame to frame. Tap **Back** to exit data playback.

12.7 Uninstall Apps

This section allows you to manage the firmware applications installed on the MaxiBAS Diagnostics System. Selecting this section opens a management screen, on which you can check all the available vehicle diagnostics applications.

Select the vehicle firmware you want to delete by tapping the vehicle brand icon, after which the selected item will display a blue check mark on the upper-right corner. Tap the **Delete** button on the top toolbar to delete the firmware from the system database.

12.8 Data Logging

The **Data Logging** section allows you to launch the Support platform to view records of all sent or unsent (saved) data loggings on the diagnostics system. For more details, please refer to [Data Logging](#).

13 Update

The internal programming of the MaxiBAS Diagnostics System, known as the firmware, can be updated through the **Update** application. Firmware updates enhance the performance of the MaxiBAS applications, typically by adding new tests, expanded vehicle coverage or enhanced applications.

The device automatically searches for available updates for all of the MaxiBAS components when it is connected to the Internet. Any updates that are found can be downloaded and installed on the device. This section describes installing an update to the MaxiBAS Diagnostics System firmware. A notification message will display if an update is available when the **Notifications** function is enabled in the **Settings** application (see [Notification Center](#)).

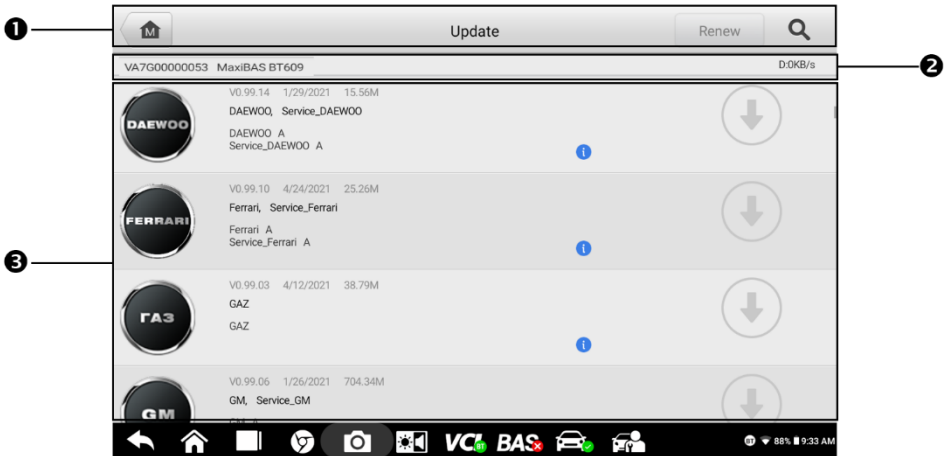

Figure 13-1 Sample Update Screen

1. Navigation and Controls
 - Home Button — returns to the MaxiBAS Job Menu.
 - Renew — tap to renew the software subscription.
 - Search Bar — searches for a specific update item by file name or keyword.
2. Status Bar
 - Left Side — displays the BT609 model information and serial number.
 - Right Side — displays an update progress bar indicating the completion status.

3. Main Section

- Left Column — displays vehicle logos and software update version information.
- Middle Column — displays a brief introduction about the new changes to the firmware operation or capabilities. Tap the ⓘ button to view more details, and tap the dim area outside the information box to close the window.
- Right Column — depending on the operation status of each firmware item, the button displays differently:
 - a) Tap **Update** to update the selected item.
 - b) Tap **Pause** to suspend the updating procedure.
 - c) Tap **Continue** to continue updating a paused update.

➤ To update the firmware:

1. Power up the tablet and ensure that it is connected to a power source and has a steady Internet connection.
2. Tap the **Update** application button from the MaxiBAS Job Menu, or tap the update notification message when received. The **Update** application screen will display.
3. Tap the **Update** button on the right column of the specific item.
4. Tap the **Pause** button to suspend the updating process. Tap **Continue** to resume the update, and the process will continue from the pause point.
5. When the updating process is completed, the firmware will be installed automatically. The new version will replace the old version.

14 Settings

Access the **Settings** menu to adjust default settings and view information about the MaxiBAS diagnostic system. The following options are available in the MaxiBAS settings menu:

- Unit
- Language
- Printing settings
- Notification center
- Auto update
- Vehicle list
- Battery Test
- System settings
- About

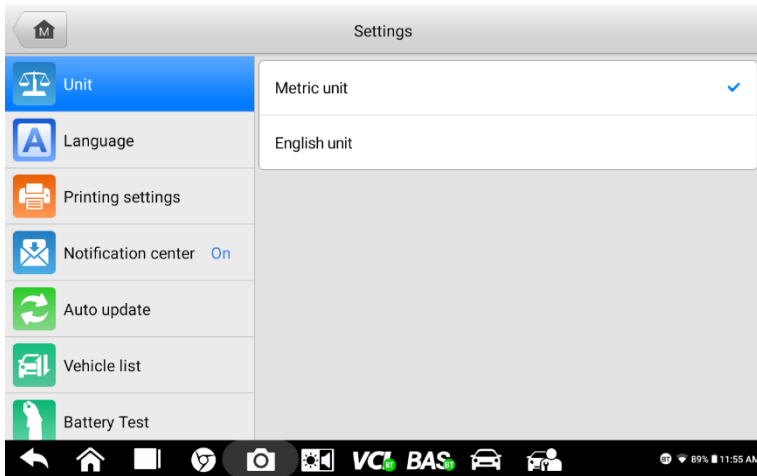

Figure 14-1 Sample Settings Screen

14.1 Unit

➤ To change the units setting:

1. Tap the **Settings** application on the MaxiBAS Job Menu.
2. Tap the **Unit** option on the left column.
3. Select the appropriate units of measurement (Metric or English). A check mark will display to the right of the selected unit.
4. Tap the **Home** button on the top-left corner to return to the MaxiBAS Job Menu, or select another settings option for further system setup.

14.2 Language

➤ **To change the language setting:**

1. Tap the **Settings** application on the MaxiBAS Job Menu.
2. Tap the **Language** option on the left column.
3. Select the appropriate language. A check mark will display to the right of the selected language.
4. Tap the **Home** button on the top left corner to return to the MaxiBAS Job Menu, or select another setting option for further system setup.

14.3 Printing Settings

This option allows you to print from the tablet to a network printer via a computer.

➤ **To set up a printer connection:**

1. Tap **Settings** on the MaxiBAS Job Menu.
2. Tap **Printing Settings** on the left column.
3. Tap **Print via network** to activate the printing function, which enables the device to send files to the printer through the computer via Wi-Fi connection.
4. Tap **Home** on the top-left corner to return to the MaxiBAS Job Menu, or select another setting option for further system setup.

14.3.1 Printing Operations

➤ **To install the MaxiSys Printer driver:**

1. Download the **Maxi PC Suite** from www.autel.com > Support > Downloads > Autel Update Tools, and install to your computer.
2. Double-click on the **Setup.exe**.
3. Select an installation language to launch the installation wizard.
4. Follow the instructions on the screen and click **Next** to continue.
5. Click **Install** and the printer driver will be installed to the computer.
6. Click **Finish** to complete the installation.

The below section describes how to receive files from the tablet and perform printing through the computer:

➤ **To print from a computer:**

1. Connect your tablet to the computer network via Wi-Fi or LAN before printing.
2. Run the **MaxiSys Printer** program on the computer.
3. Click **Test Print** to check whether the printer works properly.

4. Tap the **Print** button on the toolbar of the tablet. A test document will be sent to the computer.
 - If the **Auto Print** option in the MaxiSys Printer is selected, the MaxiSys printer will automatically print the received document.
 - If the **Auto Print** option in the MaxiSys Printer is not selected, click the **Open PDF File** button to view the files. Select the file(s) to be printed and click **Print**.

14.4 Notification Center

This option allows you to turn the **Notification Center** function on or off. The **Notification Center** function configures the MaxiBAS tablet to receive regular online messages from the server for system update notifications or other service information via the Internet. It is highly recommended that the **Notification** setting be on at all times so as not to miss news of updates or important service messages. Internet access is required for receiving online messages.

➤ **To enable the Notification Center function:**

1. Tap **Settings** on the MaxiBAS Job Menu.
2. Tap **Notification center** on the left column.
3. Tap **ON/OFF** to enable or disable the **Notifications** function. If the function is enabled, the button will display blue; otherwise, the button will display gray.
4. Tap **Home** on the top left corner to return to the MaxiBAS Job Menu, or select another setting option for further system setup.

14.5 Auto Update

This option allows you to automatically set the specific time for updating software. There are three update options: **OS Update**, **MaxiBAS Update**, and **Vehicle Update**. Tap **ON/OFF** to enable **Auto Update**. The button will display blue if **Auto Update** is enabled and will display gray if disabled. Set the time of the day for updating. If a specific time is set, the selected software will be automatically updated at the preset time.

14.6 Vehicle List

This option allows you to sort the vehicles either by alphabetic order or by using frequency.

➤ **To change the vehicle list setting:**

1. Tap the **Settings** application on the MaxiBAS Job Menu.
2. Tap **Vehicle list** on the left column.
3. Select the required sort order. A check mark will display to the right of the selected item.

4. Tap the **Home** button in the top-left corner to return to the MaxiBAS Job Menu, or select another settings option for further system setup.

14.7 Battery Test

This option allows you to enable the following functions:

- **Current clamp**

This toggle must be turned **ON** before connecting the current clamp to measure the current.

- **Visual inspection**

Turn this toggle **ON** to enable the visual inspection function.

- **Application scenarios**

Turn this toggle **ON** to enable various scenarios. For example, the In-vehicle Test main screen will only display different application scenarios (such as motorcycle, Marine, and Lawn Mower, etc.) when this function is enable. Otherwise, the main screen will only display Automobile.

14.8 System Settings

This function provides you with direct access to the Android system settings interface, where you can adjust various system settings for the Android operating system, regarding wireless and networks settings, various device settings such as sound and display, as well as system security settings, and check related information about the Android system. Refer to your Android documentation for additional information.

14.9 About

The **About** function provides information about the MaxiBAS diagnostics device including the product name, version, hardware, and serial number.

- **To check the product information in About:**

1. Tap the **Settings** application on the MaxiBAS Job Menu.
2. Tap the **About** option on the left column. The product information screen will display on the right.
3. Tap the **Home** button in the top-left corner to return to the MaxiBAS Job Menu, or select another settings option for further system setup.

15 VCI Manager

The VCI Manager is an application for connecting the MaxiBAS tablet with a VCI device and checking the communication status.

The MaxiBAS diagnostics system supports battery diagnostics with the B200 series tester.

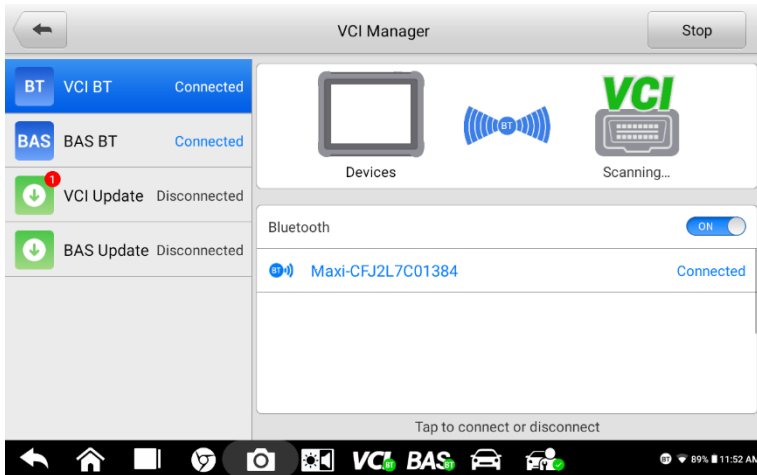

Figure 15-1 Sample VCI Manager Screen

1. **Connection Mode** — four connection modes displays. The connection status appears adjacent to each mode.
 - a) VCI BT Pairing — When the VCI is paired to a wireless device, the connection status reads “Connected”; Otherwise, it reads “Disconnected”.
 - b) BAS BT Pairing — When the battery tester is paired successfully via Bluetooth, the connection status reads “Connected”; Otherwise, it reads “Disconnected”.
 - c) VCI Update — updates VCI software via Internet through the diagnostic tablet networking via Bluetooth pairing.
 - d) BAS Update — updates the battery tester software.Select a connection mode to manage and set up a connection.
2. **Settings** — This section allows you to manage wireless connectivity.

BT Setting — searches and displays the type and partial serial number of devices available for Bluetooth pairing. Tap a device to start pairing. The BT status icon will display the received signal strength for the device.

15.1 VCI BT Pairing

Bluetooth Pairing provides a simple wireless connection. The VCI device needs to be either connected to a vehicle or to an available power source, so that it is powered up during the synchronization procedure. Make sure the tablet is fully charged or connected to a power supply.

➤ **To pair the VCI device with the tablet via Bluetooth:**

1. Power up the tablet.
2. Insert the MaxiVCI V200 into the vehicle data link connector (DLC).
3. Tap the **VCI Manager** on the MaxiBAS Job Menu.
4. Tap the **VCI BT** in the connection mode list.
5. Swipe the Bluetooth toggle button to **ON**. Tap **Scan** at the top-right corner. The device will start to search for available pairing devices.
6. Depending on the type of VCI you use, the device name may display as “Maxi” suffixed with a serial number. Tap the appropriate device for pairing.
7. When paired successfully, the connection status will read “Connected”.
8. Wait a few seconds. The **VCI** button on the system Navigation bar at the bottom of the screen will display a green BT mark, indicating the tablet is connected to the VCI device.
9. To disconnect the device, tap the connected device list again.
10. Tap **Back** on the top-left to return to the MaxiBAS Job Menu.

 **NOTE**

A VCI device can only be paired to one tablet at a time. Once paired, the device will not be discoverable for any other unit.

15.2 BAS BT Pairing

Ensure that the B200 battery tester is sufficiently charged or is connected to the external power supply before use.

➤ **To pair the B200 battery tester with the tablet:**

1. Power up the tablet and the battery tester.
2. Connect the red clamp to the positive (+) battery terminal and the black clamp to the negative (-) battery terminal.
3. Tap the **VCI Manager** on the MaxiBAS Job Menu.
4. Tap the **BAS BT** in the connection mode list.
5. Swipe the Bluetooth toggle button to **ON**. Tap **Scan** at the top-right corner. The device will start to search for available pairing units.
6. The device name may display as “Maxi” suffixed with a serial number. Select the appropriate device for pairing.
7. When paired successfully, the connection status will read “Connected”.
8. Wait a few seconds, and the **BAS** button on the system Navigation bar at the

bottom of the screen will display a green BT mark, indicating the tablet is connected to the VCI device.

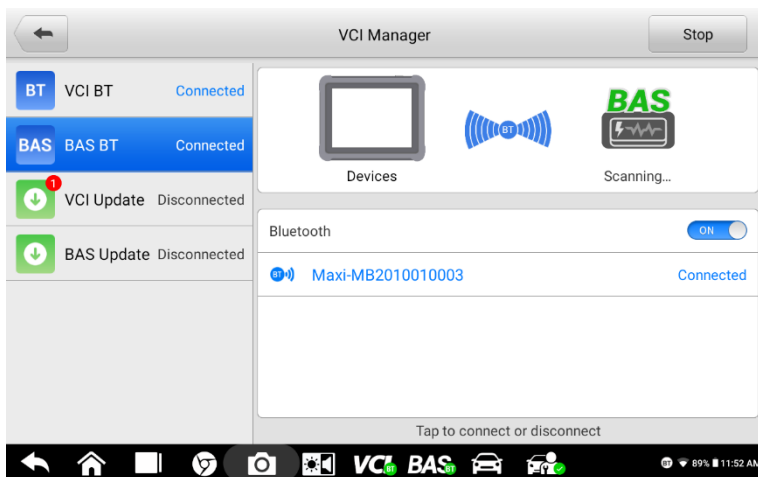

Figure 15-2 Sample BAS BT Pairing Screen

15.3 VCI Update

The Update module provides the latest update for the VCI device. Before upgrading the VCI firmware, please ensure your network connection is stable.

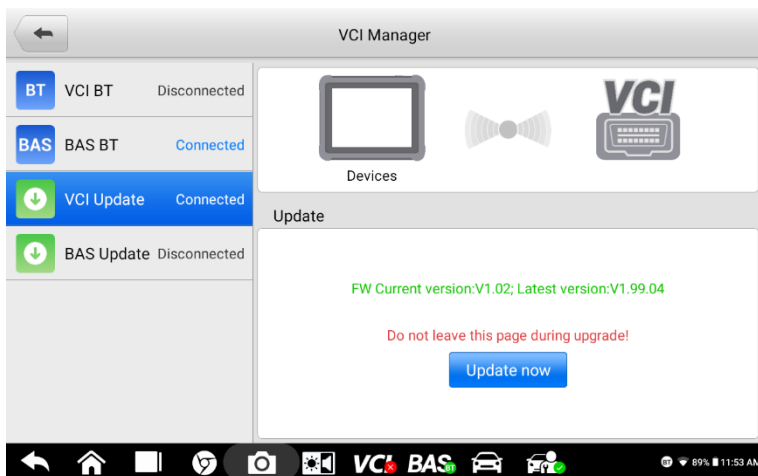

Figure 15-3 Sample VCI Update Screen

- **To update the VCI device software:**
 1. Power on the tablet.
 2. Connect the VCI device to the tablet via Bluetooth or USB cable.
 3. Tap the **VCI Manager** on the MaxiBAS Job Menu of the tablet.
 4. Select **VCI Update** from the connection mode list.
 5. The current version and the latest version of the software will be displayed. Tap **Update Now** to update the VCI software.

15.4 BAS Update

Before upgrading the B200 battery tester firmware, please ensure your network connection is stable.

- **To update the battery tester software:**
 1. Power on the tablet.
 2. Connect the battery tester to the tablet via Bluetooth or USB cable.
 3. Tap the **VCI Manager** on the MaxiBAS Job Menu of the tablet.
 4. Select **BAS Update** from the connection mode list.
 5. The current version and the latest version of the software will be displayed. Tap **Update Now** to update the battery tester software.

NOTE

The Type-C to Type-C USB cable used to connect the tablet with the VCI device or the battery tester must be purchased separately.

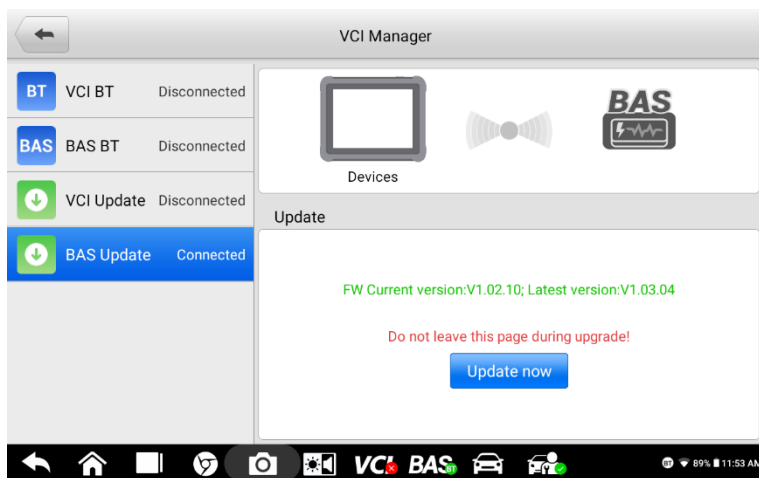

Figure 15-4 Sample BAS Update Screen

16 Support

This application launches the **Support** platform which synchronizes Autel's online support service with the MaxiBAS tablet. In order to synchronize the device to your online account, you need to register the product through the Internet when you use it for the first time. The **Support** application is connected to Autel's service channel and online communities that provides the quickest way to find solutions to common problems, allowing you to submit questions complaints and help requests to obtain direct service and support from the online community.

16.1 Product Registration

In order to get access to the **Support** platform and obtain update and other services from Autel, you are required to register the MaxiBAS diagnostics tablet the first time you use it.

➤ **To register the diagnostics tablet:**

1. Visit the website: <https://pro.autel.com/>.
2. If you already have an Autel account, sign in with your account ID and password.
3. If you are a new member to Autel, click on the **Create Autel ID** button on the left pane to create an Autel account.
4. Enter the required information, and click **Get Verification Code** button.
5. The online system will automatically send a verification code to the registered email address. Input the code in the **Verification Code** field and fill in other input fields, read through Autel's **Terms and Conditions**, click on **Agree**, and then click **Create Autel ID** at the bottom. A product registration screen will display.
6. The device's serial number and password is located in the **About** section of the **Settings** application on the tablet.
7. Select your product model, enter the product serial number and password on the **Product Registration** page, and click **Submit** to complete your registration.

16.2 Support Screen Layout

The Support application interface is navigated by the **Home** button on the top navigation bar. Use the **Home** button to return to the MaxiBAS Job Menu.

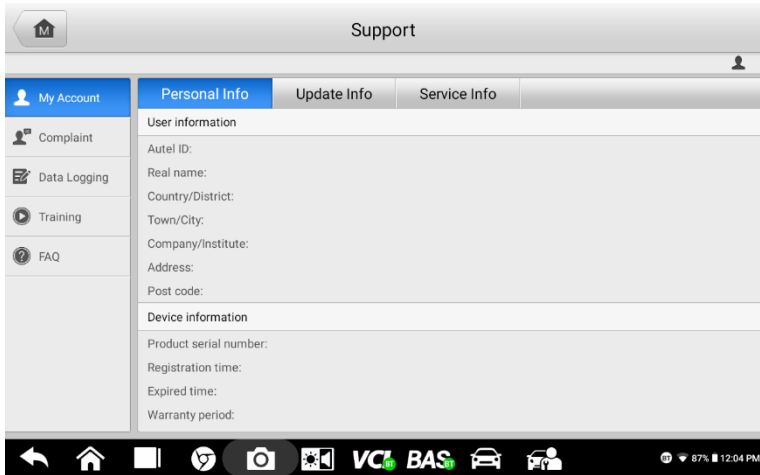

Figure 16-1 Sample Support Application Screen

The main section of the **Support** screen is comprised of two parts. The left column is the main menu; select one subject from the main menu to display the corresponding functional interface on the right.

16.3 My Account

The **My Account** screen displays the comprehensive information of the user and the product, which is synchronized with the online registered account, including **Personal Info**, **Update Info** and **Service Info**.

16.3.1 Personal Info

The **User Info** and **Device Info** are both included under the **Personal Info** section.

- User Info — displays detailed information of your registered online Autel account, such as your Autel ID, Name, Address and other contact information.
- Device Info — displays the registered product information, including the Serial Number, Registration Date, Expire Date, and Warranty Period.

16.3.2 Update Info

The Update Info section displays a detailed list of the product's software update history, including the product serial number, software version or name, and the update time.

16.3.2 Service Info

The **Service Info** section displays a detailed record list of the device's service history information. Each time the device is sent back to Autel for repair, the device's serial number and the detailed repair information, such as the fault type, changed components, or system reinstallation will be recorded and updated to the associated online product account that will be synchronized to the **Service Info** section.

16.4 Complaint

The **Complaint** screen allows you to establish a new complaint case, as well as to view historical complaint records.

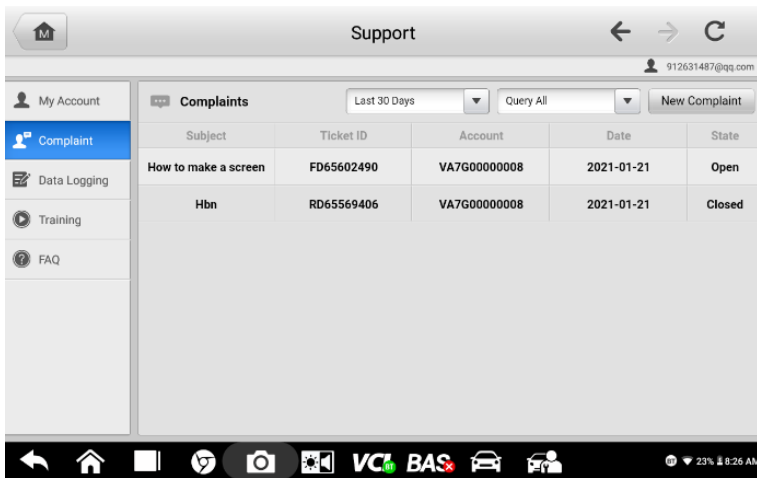

Figure 16-2 Sample Complaint Screen

Complaint List

The complaint list normally displays all the complaint records and their status by default. The summary information for each complaint item includes the Subject Name, Ticket ID, User's Account ID, Date, and the Case Status.

There are two kinds of case status:

- Open — indicates the complaint case has been started but not processed yet.
- Closed — indicates the complaint case has been processed, solved, and closed.

➤ To establish a new complaint session:

1. Register the product online.
2. Tap **Support** on the MaxiBAS Job Menu. The device information is automatically synchronized with the online account.
3. Tap **Complaint** on the Main Menu.
4. Tap **New Complaint** at the upper-right corner. A selection menu with a category

of service channels will display.

5. Select your target service channel and click **Next** to continue. A standard complaint form will display, on which you are allowed to enter detailed information, such as personal information, vehicle information, and device information. You can also attach image or PDF files to the form.
6. Enter in each input field the appropriate information. To settle the complaint more efficiently, it is recommended to complete the form with as detailed as possible.
7. Select the required processing time on the last section according to the urgency of the case.
8. Tap **Submit** to send the completed form to Autel's online service center. The submitted complaints will be carefully read and handled by the service personnel.

16.5 Data Logging

The **Data Logging** option keeps records of all **Feedback** (submitted), **Not Feedback** (not submitted but saved) or **History** (up to the latest 20 test records) data loggings on the diagnostics system. You can edit and send test records by using the **Data logging** function. Autel support personnel will receive and process submitted reports through the Support platform.

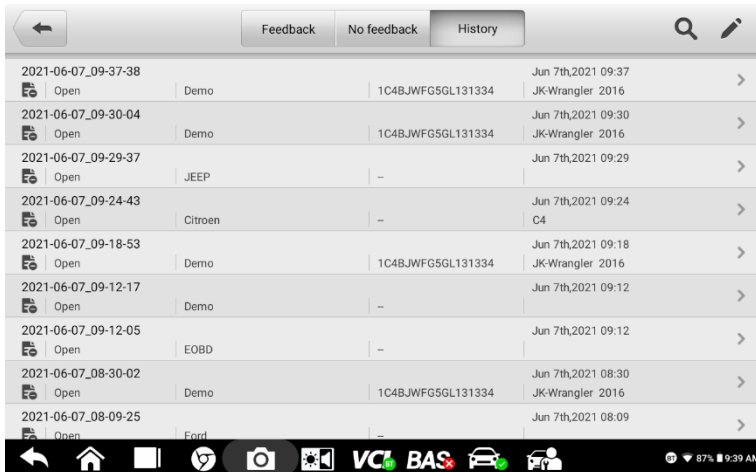

	Feedback	No feedback	History		
2021-06-07_09-37-38	Open	Demo	1C4BJWFG5GL131334	Jun 7th,2021 09:37	>
2021-06-07_09-30-04	Open	Demo	1C4BJWFG5GL131334	Jun 7th,2021 09:30	>
2021-06-07_09-29-37	Open	JEEP	-	Jun 7th,2021 09:29	>
2021-06-07_09-24-43	Open	Citroen	-	Jun 7th,2021 09:24	>
2021-06-07_09-18-53	Open	Demo	1C4BJWFG5GL131334	Jun 7th,2021 09:18	>
2021-06-07_09-12-17	Open	Demo	-	Jun 7th,2021 09:12	>
2021-06-07_09-12-05	Open	EOBD	-	Jun 7th,2021 09:12	>
2021-06-07_08-30-02	Open	Demo	1C4BJWFG5GL131334	Jun 7th,2021 08:30	>
2021-06-07_08-09-25	Open	Form	-	Jun 7th,2021 08:09	>

Figure 16-3 Sample Data Logging Screen

➤ **To issue a reply in a Data Logging section:**

1. Tap the **Feedback** tag to view the list of submitted data logs.
2. Select the latest message from Autel Tech Support.
3. Tap on the input field on the bottom of the screen and enter your reply. Additionally, you may tap the **Audio** button to record a voice message or tap the **camera** button to take a screenshot.
4. Tap **Send** to deliver your message to Autel Support.

16.6 Training

The **Training** section provides quick links to Autel's online video library. Select a video channel by language to see all available Autel online tutorial videos on topics such as product usage techniques and vehicle diagnostics practices.

16.7 FAQ

The FAQ section provides comprehensive references for all questions frequently asked and answered about the use of Autel's online member account, shopping, and payment procedures.

- Account — displays questions and answers about the use of Autel's online user account.
- Shopping & Payment — displays questions and answers about online product purchase and payment methods or procedures.

17 Remote Desktop

The Remote Desktop application launches the TeamViewer Quick Support program, which is a simple, fast, and secure remote-control interface. You can use the application to receive remote support from Autel's support center, colleagues or friends by allowing them to control your MaxiBAS tester on their PC via the TeamViewer software.

If you think of a TeamViewer connection as a phone call, the TeamViewer ID would be the phone number under which all TeamViewer Clients can be reached separately. Computers and mobile devices that run TeamViewer are identified by a unique global ID. This ID is generated automatically based on the hardware characteristics of the tablet when the **Remote Desktop** application is launched for the first time. The user cannot change the ID.

Make sure the tablet is connected to the Internet before launching the **Remote Desktop** application, so that the tablet is able to receive remote support from a third party.

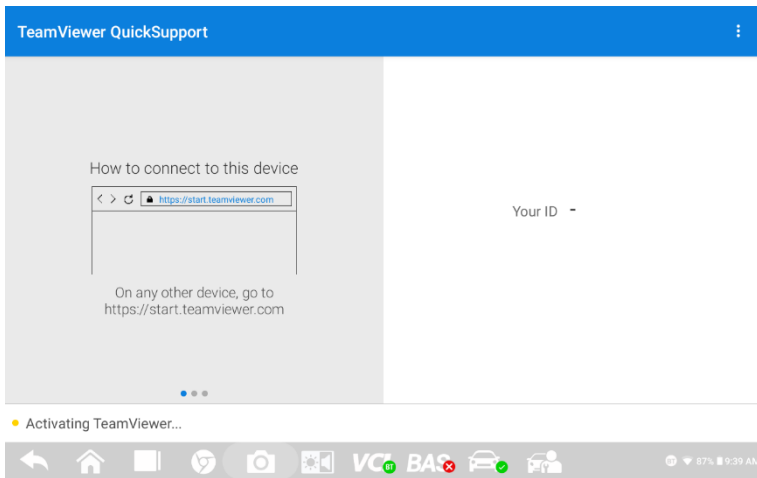

Figure 17-1 Sample TeamViewer Interface Screen

➤ **To receive remote support from a partner:**

1. Power on the tablet.
2. Tap the **Remote Desktop** application from the MaxiBAS Job Menu. The TeamViewer interface appears and the device ID is generated and shown.
3. Your partner must install the Remote Control software to his/her computer by downloading the TeamViewer program (full version) online (<http://www.teamviewer.com>). Start the software on his/her computer at the same time in order to provide support and take control of the BT608 remotely.

4. Provide your ID to the partner and have them to send you a remote control request.
5. A prompt will appear asking you to allow remote control on your device.
6. Tap **Allow** to accept or **Deny** to reject the request.

Refer to the associated TeamViewer documents for additional information.

18 Quick Link

The **Quick Link** application provides you with convenient access to Autel's official website and many other well-known sites in the automotive service industry to provide technical help, knowledge bases, forums, training and expert consultations.

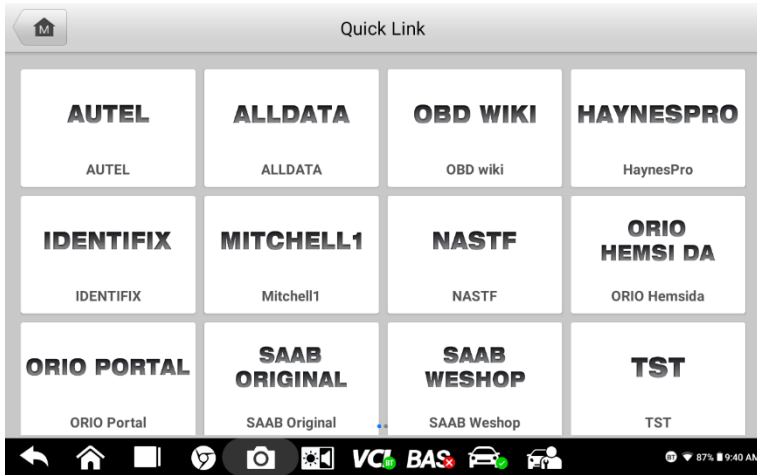

Figure 18-1 *Sample Quick Link Screen*

➤ **To open a quick link:**

1. Tap Quick Link on the MaxiBAS Job Menu. The Quick Link application screen displays.
2. Select a website thumbnail from the main section. The Chrome browser is launched and the selected website will be opened.
3. Now you can start exploring the website.

19 MaxiViewer

The **MaxiViewer** allows you to search the functions supported by our tools and the version information. There are two ways of searching, either by the tool and the vehicle or by functions.

➤ **To search by the vehicle:**

1. Tap the **MaxiViewer** application on the MaxiBAS Job Menu. The **MaxiViewer** application screen will display.
2. Tap the tool name from the drop-down list on the upper-left corner and select the one you want to search.
3. Tap the vehicle brand, model, and year you want to search.



Figure 19-1 *Sample Function Viewer Screen*

All the functions supported by the selected tool for the desired vehicle are displayed within three columns: function, sub function, and version.

➤ **To search by the functions:**

1. Tap the **MaxiViewer** application on the MaxiBAS Job Menu. The **MaxiViewer** application screen will display.
2. Tap the tool name on the top left to drop-down the tool list and select the one you want to search.
3. Enter the function you want in the top right search box. The screen will display all vehicles that support this function, along with information such as the vehicles' year, system, capacity, type, function, sub-function, and version.

**NOTE**

Partial search is supported: type in any part of the function-related keywords to find all available information.

20 Maintenance and Service

To ensure that the tablet, the battery tester, and the combined VCI unit perform at their optimum level, we advise that the product maintenance instructions covered in this section are read and followed.

20.1 Maintenance Instructions

The following shows how to maintain your devices, together with precautions to take.

- Use a soft cloth and alcohol or a mild window cleaner to clean the touch screen of the tablet.
- Do not use any abrasive cleansers, detergent, or automotive chemicals on the tablet.
- Maintain the devices in dry conditions and keep them within normal operating temperatures.
- Dry your hands before using the tablet. The touchscreen of the tablet may not work if the touchscreen is moist, or if you tap the touchscreen with wet hands.
- Do not store the devices in humid, dusty or dirty areas.
- Check the housing, wiring, and connectors for dirt and damage before and after each use.
- At the end of each work day, wipe the device housing, wiring, and connectors clean with a damp cloth.
- Do not attempt to disassemble the tablet, the battery tester or the VCI unit.
- Do not drop or cause severe impact to the devices.
- Use only authorized battery chargers and accessories. Any malfunction or damage caused by the use of unauthorized battery charger and accessories will void the limited product warranty.
- Ensure that the battery charger does not come in contact with conductive objects.
- Do not use the devices beside microwave ovens, cordless phones and some medical or scientific instruments to prevent signal interference.

20.2 Troubleshooting Checklist

A. When the tablet does not work properly:

- Make sure the tablet has been registered online.
- Make sure the system software and diagnostic application software are properly updated.
- Make sure the tablet is connected to the Internet.
- Check all cables, connections, and indicators to ensure the signal is being received.

B. When battery life is shorter than usual:

- This may happen when you are in an area with low signal strength. Turn off your device if not in use.

C. When you cannot turn on the tablet:

- Make sure the tablet is connected to a power source or the battery is charged.

D. When you are unable to charge the tablet:

- Your charger maybe out of order. Contact your local distributor for assistance.
- You may be attempting to use the device in an overly hot/cold temperature. Charge the device in a cooler or warmer area.
- Your device may have not been connected to the charger properly. Check the connector.

 **NOTE**

If the problems persist, please contact the Autel technical support personnel or your local distributor.

20.3 About Battery Usage

Your tester is powered by a built-in Lithium-ion Polymer battery. This means that, unlike other forms of battery technology, you can recharge your battery while some charge remains without reducing your tester's autonomy due to the "battery memory effect" inherent in those technologies.

 **DANGER**

1. The built-in Lithium-ion Polymer battery is factory replaceable only; incorrect replacement or tampering with the battery pack may cause an explosion.
 2. Do not use a damaged battery charger.
-
- Do not disassemble or open, crush, bend or deform, puncture or shred.
 - Do not modify or remanufacture, attempt to insert foreign objects into the battery, expose to fire, explosion or other hazards.
 - Make sure to use the charger and USB cables that come together in the package only. If you use the other charger and USB cables, you might incur malfunction or failure of the device.
 - Only use the charging device that has been qualified with device per the standard. Use of an unqualified battery or charger may present a risk of fire, explosion, leakage, or other hazards.
 - Avoid dropping the tester. If the tester is dropped, especially on a hard surface, and the user suspects damage, contact support.
 - The battery recharging time varies depending on the remaining battery capacity.
 - Battery life inevitably shortens over time.
 - Since over charging may shorten battery life, remove the tester from its charger once it is fully charged. Unplug the charger once charging is complete.
 - Leaving the tester in hot or cold places, especially inside a car in summer or winter, may reduce the capacity and life of the battery. Always keep the battery within normal temperatures.

20.4 Service Procedures

This section introduces information for technical support, repair service, and application for replacement or optional parts.

20.4.1 Technical Support

If you have any question or problem on the operation of the product, please contact us.

AUTEL NORTH AMERICA

- **Phone:** 1-855-AUTEL-US (288-3587) (855-288-3587) Monday-Friday 9am-6pm EST
- **Website:** www.autel.com
- **Email:** ussupport@autel.com
- **Address:** 175 Central Avenue, Suite 200, Farmingdale, New York, USA 11735

AUTEL EUROPE

- **Phone:** 0049 (0) 6103-2000520 Monday-Friday, 9:00am-6:00pm Berlin Time
- **Website:** www.autel.eu
- **Email:** sales.eu@autel.com, support.eu@autel.com
- **Address:** AdalperostraÙe 82, 85737 Ismaning, Germany

AUTEL CHINA HQ

- **Phone:** 0086-755-2267-2493 Monday-Friday, 9:00AM-6:00PM Beijing Time
- **Website:** www.autel.com
- **Email:** support@autel.com
- **Address:** 7th, 8th and 10th floor, Building B1, Zhiyuan, Xueyuan Road, Xili, Nanshan, Shenzhen, 518055, China.

AUTEL LATIN AMERICA

- **Website:** www.autel.com
- **Email:** sales.latin@autel.com, latsupport02@autel.com
- **Address:** Avenida Americas 1905, 6B, Colonia Aldrete, Guadalajara, Jalisco, Mexico

AUTEL APAC

- **Phone:** +045 5948465
- **Website:** www.autel.com/jp/
- **Email:** sales.jp@autel.com, support.jp@autel.com
- **Address:** 719, Nissou Building, 3-7-18, Shinyokohama, Kouhoku, Yokohama, Kanagawa, Japan 222-0033

Autel IMEA DMCC

- **Phone:** +971 585 002709
- **Website:** www.autel.com
- **Email:** sales.imea@autel.com, imea-support@autel.com
- **Address:** Office 1006-1010, Cluster C, Fortune Tower, Jumeirah Lakes Tower (JLT), Dubai, U.A.E

For technical assistance in other markets, please contact your local distributor.

20.4.2 Repair Service

If it becomes necessary to return your device for repair, please download the repair service form from www.autel.com, and fill in the form. The following information must be included:

- Contact name
- Return address
- Telephone number
- Product name
- Complete description of the problem
- Proof-of-purchase for warranty repairs
- Preferred method of payment for non-warranty repairs

NOTE

For non-warranty repairs, payment can be made with Visa, Master Card, or with approved credit terms.

Send the device to your local distributor, or to the below address:

7th, 8th and 10th Floor, Building B1, Zhiyuan, Xueyuan Road, Xili, Nanshan, Shenzhen, 518055, China

21 Compliance Information

FCC Compliance

FCC ID: WQ8MAXIBASBT609

This device complies with part 15 of the FCC Rules and Industry Canada's license-exempt RSSs. Operation is subject to the following two conditions:

1. This device may not cause harmful interference, and
2. This device must accept any interference received, including interference that may cause undesired operation.

Cet appareil est conforme aux CNR exempts de licence d'Industrie Canada. Son fonctionnement est soumis aux deux conditions suivantes:

1. Ce dispositif ne peut causer des interférences; et
2. Ce dispositif doit accepter toute interférence, y compris les interférences qui peuvent causer un mauvais fonctionnement de l'appareil.

WARNING

Changes or modifications not expressly approved by the party responsible for compliance could void the user's authority to operate the equipment.

NOTE

This equipment has been tested and found to comply with the limits for a Class B digital device, pursuant to Part 15 of the FCC Rules. These limits are designed to provide reasonable protection against harmful interference in a residential installation.

This equipment generates uses and can radiate radio frequency energy and, if not installed and used in accordance with the instructions, may cause harmful interference to radio communications. However, there is no guarantee that interference will not occur in a particular installation. If this equipment does cause harmful interference to radio or television reception, which can be determined by turning the equipment off and on, the user is encouraged to try to correct the interference by one or more of the following measures:

- Reorient or relocate the receiving antenna.
- Increase the separation between the equipment and receiver.
- Connect the equipment into an outlet on a circuit different from that to which the receiver is connected.
- Consult the dealer or an experienced radio/TV technician for help.

SAR

The radiated output power of this device is below the FCC radio frequency exposure limits. Nevertheless, the device should be used in such a manner that the potential for human contact is minimized during normal operation.

The exposure standard for wireless devices employs a unit of measurement known as the Specific Absorption Rate, or SAR. The SAR limit set by the FCC is 1.6 W/Kg. Tests for SAR are conducted using standard operating positions accepted by the FCC with the device transmitting at its highest certified power level in all tested frequency bands.

Although the SAR is determined at the highest certified power level, the actual SAR level of the device while operating can be well below the maximum value. This is because the device is designed to operate at multiple power levels so as to use only the power required to reach the network. To avoid the possibility of exceeding the FCC radio frequency exposure limits, human proximity to antenna should be minimized.

The highest SAR value reported under this standard during product certification for use when properly worn on the body is 1.421 W/kg.

FCC Radiation Exposure Statement

This equipment complies with FCC radiation exposure limits set forth for an uncontrolled environment. This equipment should be installed and operated with minimum distance 20cm between the radiator & your body.

RoHS COMPLIANCE

This device is declared to be in compliance with the European RoHS Directive 2015/863/EU.

CE COMPLIANCE

This product can be used across EU member states.

We declares that this device is in compliance with the essential requirements and other relevant provisions of Directive 2014/53/EU.



22 Warranty

Limited One Year Warranty

Autel Intelligent Technology Corp., Ltd. (the Company) warrants to the original retail purchaser of this MaxiBAS tablet that should this product or any part thereof during normal usage and under normal conditions be proven defective in material or workmanship and results in product failure within 1 year period from the date of purchase, such defect(s) will be repaired, or replaced (with new or rebuilt parts) with Proof of Purchase, at the Company's option, without charge for parts or labor directly related to the defect(s).

The Company shall not be liable for any incidental or consequential damages arising from the use, misuse, or mounting of the device. Some states do not allow limitation on how long an implied warranty lasts, so the above limitations may not apply to you.

This warranty does not apply to:

1. Products subjected to abnormal use or conditions, accident, mishandling, neglect, unauthorized alteration, misuse, improper installation or repair or improper storage;
2. Products whose mechanical serial number or electronic serial number has been removed, altered or defaced;
3. Damage from exposure to excessive temperatures or extreme environmental conditions;
4. Damage resulting from connection to, or use of any accessory or other product not approved or authorized by the Company;
5. Defects in appearance, cosmetic, decorative or structural items such as framing and non-operative parts.
6. Products damaged from external causes such as fire, dirt, sand, battery leakage, blown fuse, theft or improper usage of any electrical source.

! IMPORTANT

All contents of the product may be deleted during the process of repair. You should create a back-up copy of any contents of your product before delivering the product for warranty service.
